



*An Online CPD Course
brought to you by
CEDengineering.ca*

Alternatives to Active HVAC Systems

Course No: M06-016

Credit: 6 PDH

A. Bhatia

CED CANADA
engineering.ca
CPD FOR THE PROFESSIONAL

Continuing Education and Development, Inc.

P: (877) 322-5800

info@cedengineering.ca

www.cedengineering.ca

ALTERNATIVES TO ACTIVE HVAC SYSTEMS

The space conditioning may be provided by active cooling systems or passive systems. The active cooling systems generally consist of electricity powered vapor compression refrigeration equipment which consumes significant energy. It is not always necessary to install a complex active system to realize an acceptable thermal condition indoors. Good thermal insulation, low proportion of glazing, outdoor solar shading, the use of thermal mass, night ventilation and alternate cooling technologies can sometimes jointly make an active cooling system redundant. These forms of passive climate controls need less energy, for cooling as well as heating, and make the indoor environment more stable. Even in combination with an active climate control system, good passive design can make the environmental conditions more comfortable.

Passive cooling works on two basic concepts:

1. Minimizing or preventing heat gain and
2. Rejecting unwanted heat

Heat-gain control is simple and effective strategy. It involves intervening the external setting by means of reducing the impact of solar radiation and internal heat gains. The simplest and most effective passive cooling techniques include:

- **Building Orientation:** Keep out the sun's heat from entering the building. The fact the sun is lower in the sky in winter than in summer allows us to plan and construct buildings that capture that free heat in winter and reject it in summer. The orientation of the whole building plays an important part; the ideal orientation for hot and dry climates should be to keep long axis of the building East-West. This will reduce the heat gain. Conversely, buildings with their long axis running north/south will have higher peak cooling loads and will require larger cooling equipment and obviously high energy costs.

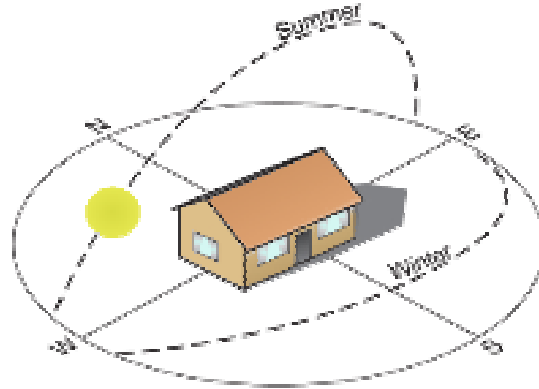

- **Vegetation:** When deciding the orientation, take into account the location of landscape. Mitigation of undesirable summer direct sun is achieved through use of vegetation; for example planting deciduous trees interrupt the summer sun's direct path, and ground covers of grass prevent ground reflection as well as keep the earth's surface cooler.
- **Shading:** If vegetation is impractical, combinations of overhangs, awnings, exterior shades, venetian blinds, curtains and drapers are effective strategies. The effectiveness of sun shades is not equal for all orientations of walls and therefore glazed areas should be provided only in those positions where effective protection against the sun can be ensured. Protection against diffused and reflected radiation cannot be provided by any simple method. To reduce heat gain through glazed areas they should be kept to the minimum for good day light.
 - Shading against direct radiation is easiest to provide on the south wall. A horizontal projection of at least half the window height will exclude the summer sun while still permitting sun light in the building in winter.
 - Mitigation of heat through roof and the east/west walls requires a different approach. Since the sun is low in the horizon during sunrise and sunset, overhangs are not effective and vertical louvers, or a movable screen is a better option. Vegetation is perhaps the most effective way of keeping the intense morning and afternoon sun off the east and west walls and windows, but care must be taken to avoid blockage of nighttime summer breezes that can be part of the diurnal cooling strategy.
 - The north wall can be protected by vertical louvers.

- The roof can be shaded only by a horizontal cover extending over the whole roof and projecting beyond it on the east, west and south sides.
- **Building finishes:** Light-colored paints and materials on the roof and the walls have low absorption coefficient that has an important advantage of reflecting much more heat than darker materials do. A white roof may absorb only 25 percent of solar heat, far less than the 90 percent absorbed by a black one. This greatly reduces the amount of heat getting into the building and simplifies the task of comfort cooling. Whitewash with lower reflectivity than aluminum will stay cooler when exposed to solar radiation because of its very high emissivity. Roof surfaces, which are exposed to solar radiation for long hours in summer, should be painted white.
- **Building construction:** A building characterized by high thermal mass act as "heat sponges", absorbing heat and slowing internal temperature rise on hot days. The effect of massive construction is to lower the maximum day time temperature and to raise the minimum night time temperature. In warm climates it is advantageous to use massive building construction. The uncomfortable night time conditions in such structures can be modified by introducing additional ventilation into the building at night. High thermal mass construction is particularly desirable in regions with large diurnal ranges. They serve no useful purpose in climates with small diurnal temperature changes. For composite climates a combination of light weight and heavy construction is desirable. Historically, building materials in temperate regions adopt the low mass approach, using walls and floors of wood, which doesn't store much heat. Others, needing insulation against winter cold, have learned to use dense adobe or masonry walls.
- **Glazing:** Appropriate windows and glazing with low thermal conductivity (double glazing with inert gas) and coated with reflective film keep out more heat while remaining transparent. Wooden or PVC frames are better option for glazing and Aluminum if used shall be fabricated with thermal break.
- **Insulation:** The demand for heating or cooling can be significantly reduced, by designing a building envelope with effective and efficient insulation. The following outlines the basic steps to achieve maximum effectiveness in insulation:

- Insulate attic, outside walls, floors over crawl space, etc.
- Add insulation to attic access panels or pull down stairs.
- Install insulation in gaps around pipes, ducts, fans or other items which enter the attic or exit the house from a conditioned space.

Air cavities can be used in place of resistance insulation. By ventilating these cavities to the outside at certain times of the day or during a particular season, their resistance value can be decreased. In other words, air cavities can be employed to create wall or roof element with flexible conductivity (u-value). A similar effect is achieved by applying movable insulation to a fixed building element, although at much greater cost.

- **Radiant barriers:** Radiant barriers are materials that are installed in buildings to reduce summer heat gain and winter heat loss, and hence to reduce building heating and cooling energy usage. Radiant barriers usually consist of a thin sheet or coating of a highly reflective material, usually aluminum, applied to one or both sides of a number of substrate materials. These substrates include kraft paper, plastic films, cardboard, plywood sheathing, and air infiltration barrier material. Some products are fiber reinforced to increase the durability and ease of handling. Radiant barrier materials must have high reflectivity (usually 0.9, or 90%, or more) and low emissivity (usually 0.1 or less), and must face an open air space to perform properly. For a material that is opaque (that is, it does not allow radiation to pass directly through it), when the emissivity and reflectivity are added together, the sum is one (1). Hence, a material with a high reflectivity has a low emissivity, and vice versa.

Radiant barriers perform a function that is similar to that of conventional insulation, in that they reduce the amount of heat that is transferred into the building. They differ in the way they reduce the heat flow. When a radiant barrier is placed on the attic floor, much of the heat radiated from the hot roof is reflected back toward the roof. This makes the top surface of the insulation cooler than it would have been without a radiant barrier and thus reduces the amount of heat that moves through the insulation into the rooms below the ceiling.

- **Control of Internal Heat Gain of the Building:** If a building is fully insulated from the outdoor thermal environment, with normal use its internal temperature will rise because of the accumulation of heat from within the building. People, lights, machines, kitchen stoves and many such devices used in buildings produce heat. To prevent the accumulation of heat from individual sources like machines and kitchens, they should be thermally isolated from living areas and if possible they should be ventilated to the outside.

Within the living and working areas, the heat produced from lights can be reduced by using more efficient luminaries and by proper day lighting of the building, as daylight (not direct sun light) has higher light to heat ratio than most artificial light sources. Use of premium efficiency motors and energy star rating appliances are not only low on energy consumption but also low on cooling load.

- **Natural Airing:** Design for natural ventilation especially for night cooling. A constant supply of fresh outdoor air can provide a greater assurance of good indoor air quality and improved comfort. Too much fresh air may cause uncomfortable drafts and high energy bills. Not enough fresh air can lead to poor indoor air quality.
- **Reduce Infiltration:** Air leakage through the building envelope accounts for between 25 percent and 40 percent of the energy used for heating and cooling. Tighter building construction can improve the energy efficiency, air quality, and comfort by eliminating unwanted drafts. There are hundreds of penetrations through a typical building's exterior. These gaps and holes are often incurred during framing, and from penetrations for wiring, plumbing, and ducts. Today, off-the-shelf technologies such as house wraps, sealants, foams, and tapes reduce air infiltration. Use outlet and switch plate gaskets to reduce air infiltration. Caulk, seal and weather strip around windows/doors.

The heat control methods as above should suffice to keep buildings comfortable during mild summer temperatures but there are many harsh hot and arid regions of the southwest, where additional cooling sources may be necessary. The following methods may be used:

1. Ventilation / night cooling
2. Evaporative cooling

3. Absorption chiller
4. Desiccant cooling
5. Radiative cooling
6. Ground coupling and heat pumps (thermoelectric and geothermal)

We will discuss the key notions pertaining to these technologies in following sections.

SECTION # 1

VENTILATION AND NIGHT COOLING

Night cooling is an established technique allowing natural ventilation to take place at night with the intention of removing heat gains that have built up during the preceding day. The term ventilation includes all thermal procedures where air in the interior of closed space is replaced by external air masses, entering through building openings. The natural ventilation contributes to the improvement of thermal comfort and quality condition of the internal air, while at the same time it is recognized as a very efficient technique that, when applied properly, leads to significant reduction of energy consumption for the cooling of buildings.

In a naturally ventilated building, air is driven in and out due to pressure differences produced by wind or buoyancy forces between a building and its environment. There are two fundamental approaches to designing for natural ventilation:

1. Stack ventilation which uses the increased buoyancy of air as it warms up;
2. Wind driven ventilation which uses air-pressure differentials caused by wind.

Both work on the principle of air moving from a high pressure to a low pressure zone. The difference is that the pressure differences that causes wind driven ventilation uses the forces of the wind where as stack ventilation is caused by pressures generated due to temperature differentials. Ventilation due to wind forces is of a higher order than due to thermal forces, but due to the intermittent nature of wind movement, such ventilation cannot be ensured at the most appropriate times. Therefore, there are different approaches in the optimization of the two types of natural ventilation.

The following paragraphs highlight the controlled natural ventilation designs.

Stack Ventilation

Stack flow is driven by the difference between the inside and outdoor air temperature. Assuming that the indoor temperature is above the outdoor value, the inside air is less dense and therefore lighter than the outside air. As a consequence, the vertical pressure gradient, exerted by the indoor air, is steeper, resulting in a pressure imbalance. If the enclosed space is penetrated by openings at different heights, air flows through openings at the lowest level and escapes through the upper openings. This flow process is reversed if the indoor temperature is less than the outdoor temperature.

An expression for the airflow induced by the stack effect is:

$$Q_{\text{stack}} = C_d \times A \times [2gh (T_i - T_o) / T_i]^{1/2}$$

Where

- Q_{stack} = volume of ventilation rate (m^3/s)
- $C_d = 0.65$, a discharge coefficient
- A = free area of inlet opening (m^2)
- $g = 9.8 \text{ (m/s}^2\text{)}$ the acceleration due to gravity
- h = vertical distance between inlet and outlet midpoints (m)
- T_i = average temperature of indoor air (K)
- T_o = average temperature of outdoor air (K)

From the equation, it can be seen the rate of air flow is proportional to the difference of temperature between the inside and outside air, and the difference in the height of the outlet and the openings of the inlet. The greater the vertical distance between the inlet and outlet openings, the greater will be the ventilation rate.

An increase in the internal air temperature over the external air temperature will cause greater ventilation, but the higher internal temperature will also result in thermal discomfort. Stack effect has a greater influence at night than during the day since a larger temperature differential exists between the internal and external temperature at night.

The stack should be elevated so that the neutral pressure level (NPL*) is high enough to provide sufficient driving force to draw air out of the building at the top floor. [*The location at which the indoor and outdoor pressures are in balance is called the neutral pressure level (NPL). If an opening were present at this opening, there would be no airflow through it. Below the neutral pressure level, the internal pressure is less than the external, providing the external temperature is below the internal temperature, and consequently flow will occur into the building. Above neutral pressure level, the opposite is true, and flow will be out of the building. However, if the internal temperature is less than outside, air flow will be reversed]. Vertical airshafts or open staircases can be used

to increase and take advantage of stack effects. Openings in the vicinity of the Neutral Pressure Level (NPL) are least effective for thermally induced ventilation; if the building has only one large opening, the NPL tends to move to that level, which reduces the pressure across the opening.

The maximum difference between the outlet and the inlet heights is generally determined by the height of the building, but in exceptional cases it is possible to increase this difference by building tall wind towers.

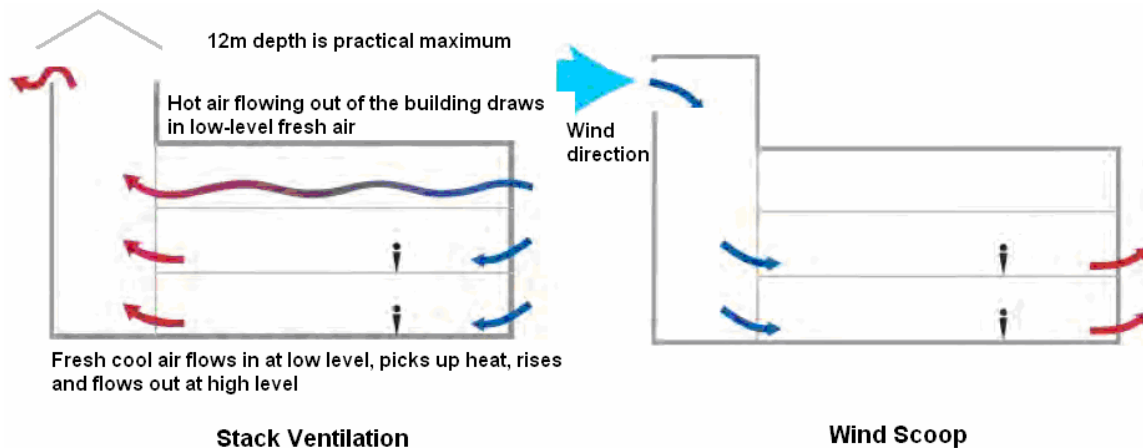

Wind Driven Ventilation

As naturally occurring wind blow across a building, the wind hits the windward wall causing a direct positive pressure. The wind moves around the building and leaves the leeward wall with a negative pressure, also known as a sucking effect. If there are any openings on the windward and leeward walls of the building, fresh air will rush in the windward wall openings and exit the leeward wall openings to balance and relieve the pressures on the windward and leeward walls.

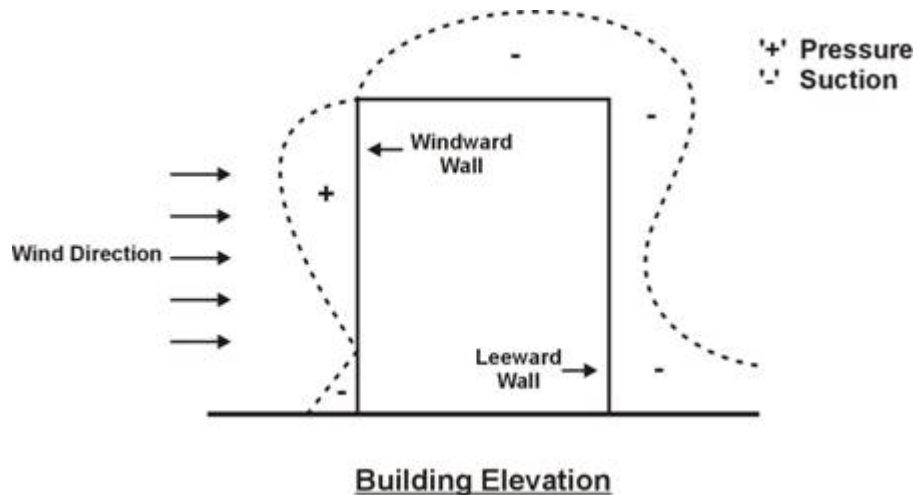

The building shape is therefore a crucial factor to effectively drive the air flow through the openings of the building. An expression for the volume of airflow induced by wind is:

$$Q_{\text{wind}} = K \times A \times V$$

Where

- Q_{wind} = volume of airflow (m^3/h)
- A = area of smaller opening (m^2)
- V = outdoor wind speed (m/h)
- K = coefficient of effectiveness. [The coefficient of effectiveness depends on the angle of the wind and the relative size of entry and exit openings and ranges from 0.4 to 0.8].

The ventilation rate is determined by the geometry and construction of building and on two continuously changing factors: wind availability and wind direction. Designing building for wind-driven natural ventilation requires some understanding of the forms and configurations; treatments of external envelopes; and some special features such as location of service core; atria, open central corridors, open ground floor and external wind scoops. Recommendations are:

- The wind creates a high pressure zone where it impacts the building and a low pressure zone on the leeward side. Pressure is highest near the centre of the

- windward wall diminishing to the edges as the wind finds other ways to move around the building so air intakes shall be located preferable near the centre.
- The flow through a building is related to the size of the openings (both inlets and outlets), restrictions along the flow path, furnishings and the distance between openings. An inlet window smaller than the outlet creates higher inlet velocities. To get the best cooling rates, the area of the opening at exhaust (leeward side) should be 25 to 50% larger than the intake openings on the windward side of the building;
 - The inlet location affects airflow patterns far more significantly than outlet location. Inlet location should be a higher priority (if faced with a choice) as a high inlet will direct air toward the ceiling and may bypass the occupied level;
 - Building should be oriented so that the windward wall is perpendicular to the summer wind i.e. when you want to maximize the ventilation. If there is no prevailing direction, cool air intake vents are best located as low as possible on the *north* side.
 - Building should not be too deep else it will be difficult to distribute outside air to all portions. Shape the building to expose maximum surface area to breezes. Use architectural elements such as wing-walls, parapets, and overhangs to promote airflow into the building interior;
 - The building should preferably be designed with end cores located at the hottest parts of the building, i.e. the East and West walls. This is to create buffer zones separating the working area and the hot walls.

Design Classifications of Wind Driven Natural Ventilation

In natural ventilation systems there are two major design foundations; cross ventilation and single sided ventilation.

Cross ventilation

Cross ventilation is achieved when rooms with a double orientation with at least two walls face externally in opposite directions. Cross ventilation provides multiple openings on different facades of a building. The action of any wind will then generate pressure differences between those openings and so promote a robust airflow through an internal

space. Cross flow ventilation results in higher air change rates, and can ventilate a deeper floor plate (five times the floor-ceiling height). Cross ventilation is thus the design type of choice.

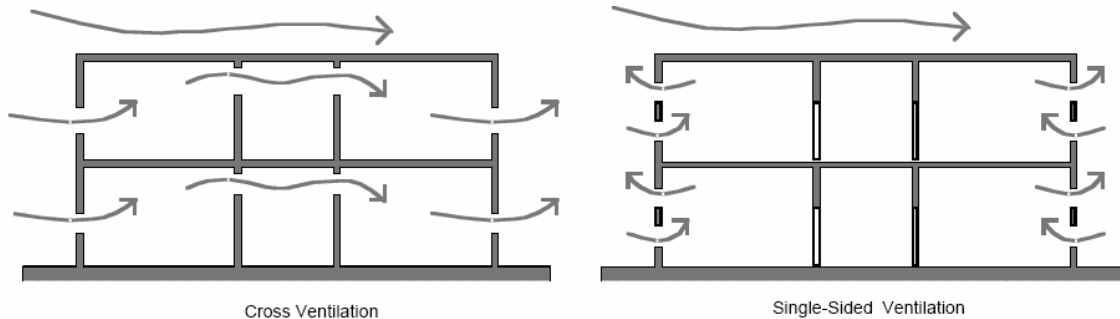

Single-sided ventilation

There are many instances, such as in small cellular offices within a large building, where there may be only one external facade. In those cases single-sided ventilation must be used. In these systems, wind driven ventilation flow is dominated by the turbulence of the wind, as caused by temporal changes in wind speed and direction, and as generated the building itself and its neighbors. Single-sided ventilation may produce significantly less airflow than cross ventilation, so that the size and placement of openings can be critical in achieving a successful design having adequate and robust ventilation.

Effectiveness of Natural Ventilation

Effectiveness of natural ventilation depends on the lay-out of buildings. Rooms with a double orientation with at least two walls facing externally but in opposite directions make for effective ventilation.

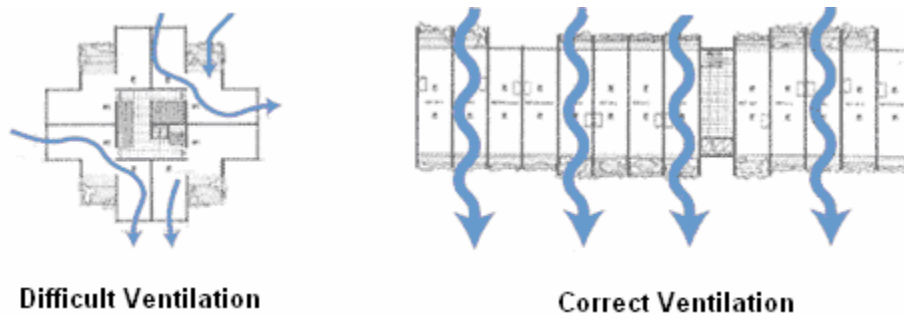

The general rules of thumb:

1. Single-sided ventilation is OK if
 - It is not possible to locate openings on the opposite walls and;
 - Single-sided ventilated spaces with high-openings are effective to a depth of about 2 times the room height;
 - Single-sided ventilated spaces with high and low-openings are effective to a depth of 2.5 times the room height.
2. Cross-ventilation works well when
 - Inlet and outlet openings are located in opposing pressure zones. Inlets should supply air at a location low in the room and outlets should be located across the room and at a higher level;
 - if the room width is up to 5 times the room height;
3. Recommendations on windows:
 - Awning windows work for air intakes, hopper windows for outflow;
 - Double hung windows are ideal for single sided ventilation because they provide high and low openings in the one unit;
 - Casement windows are suitable to catch breezes when the prevailing wind direction is consistent; these however are much less effective in comparison to sliding windows;
 - Horizontal windows are generally better than square or vertical windows. They produce more airflow over a wider range of wind directions and are most beneficial in locations where prevailing wind patterns shift;
 - Window insect screens decrease the flow rate of slow breezes more than stronger breezes (60% decrease at 2.4 km/h, 28% decrease at 9.7km/h);
 - Windows should have effective seals to avoid unwanted infiltration.

Equipments/Tools to Aid Natural Ventilation

Turbine Vents:

Turbine vents use the natural force of wind and air pressure to spin and vent out stale attic air. They do it with a series of specially shaped vanes that catch the wind and provide rotary motion. The centrifugal force caused by the spinning vanes creates a region of low-pressure area, which draws air out through the turbine exhaust. Warm air drawn out by the turbine exhaust is continuously replaced by fresh air. The slightest breeze will cause the turbine exhaust to spin and even with negligible breeze, the flywheel effect of the rotor cage will use its stored energy to continuously remove air. These turbine ventilation systems require little maintenance and provide excellent performance and energy savings.

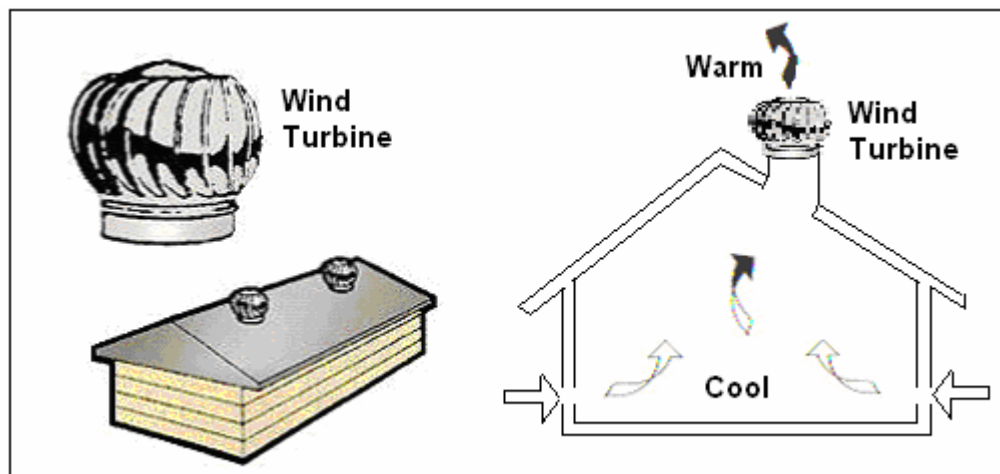

Turbine Vents

Solar Chimney:

A solar chimney — often referred to as a thermal chimney — use convection of air heated by passive solar energy. In its simplest form, the solar chimney consists of a black-painted chimney. During the day time, solar energy heats the chimney and the air within it, creating an updraft of air. The suction created at the chimney's base ventilates and cool the building's space below.

A simple description of a solar chimney is a hollow thermal mass connecting the interior and exterior of a building. As the air inside the hollow mass warms utilizing solar energy (using PV panels), it aids an updraft that pulls air through the building.

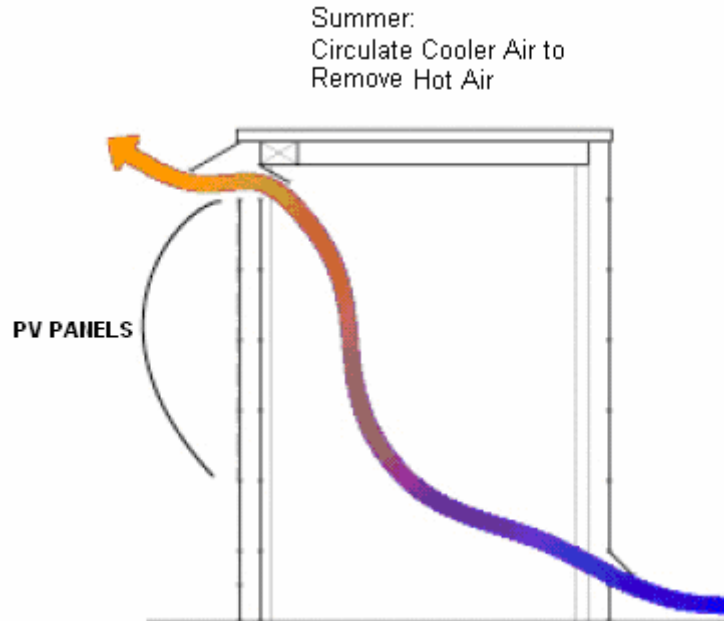

Trombe Wall:

The solar chimney can be improved by integrating it with a trombe wall. A Trombe wall is a passive solar heating and ventilation system consisting of an air channel sandwiched between a window and a thermal mass. During the ventilation cycle, sunlight stores heat in the thermal mass and warms the air channel causing circulation through vents at the top and bottom of the wall. Sunlight striking the concrete wall will heat the air in the space between glass and wall to temperatures above 150°F. This very hot air rises quickly and escapes, drawing cool air into the house through low vents on the north wall. Additionally, specifically constructed "solar chimneys", composed of passive air heaters with seasonal dampers can be incorporated where solar heated air can be dumped into the building in the winter, and used as a "ventilator driver" in the summer to draw outdoor air through a house and ventilate it. Frequently, they can induce air velocities of 1-2 feet per second.

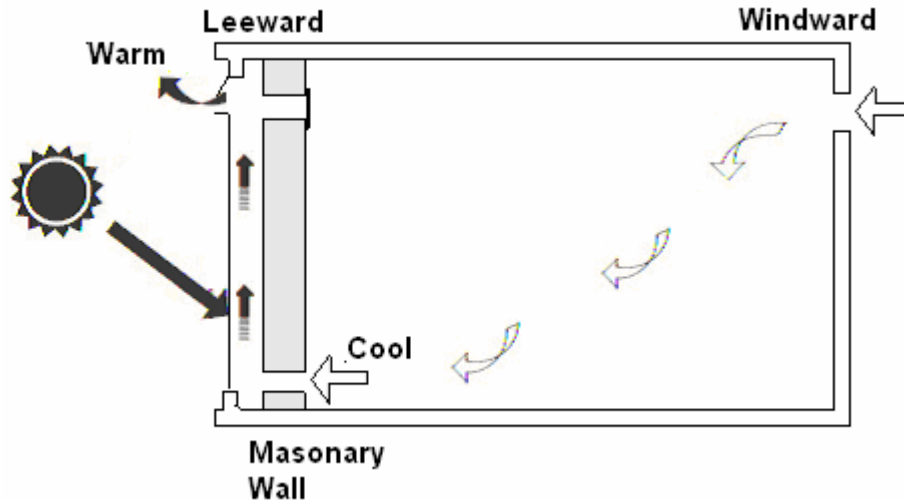

Use of Trombe Wall in Summer Cooling

Earth Cooling:

Conductive heat loss in a building normally occurs through the floor. The diurnal variations in air temperature affect only the top layer of the soil (30 cm) and even the seasonal variations of temperature are not felt below a few meters depth. The ground temperature a few meters below the surface remains constant throughout the year. The magnitude of this constant temperature depends upon the nature of the ground surface, the lowest temperatures resulting from a shaded and irrigated surface.

If buildings are constructed at depths below the surface, it would be naturally cooled in summer and heated in winter. However, it is not practical to build every building at a depth. An alternative method is to construct tunnels at the appropriate depth and to cool air by drawing it through the tunnels. The cooled air is then blown into the living spaces in the building.

An important design parameter for such tunnels is the total surface area of the tunnel across which the heat exchange takes place.

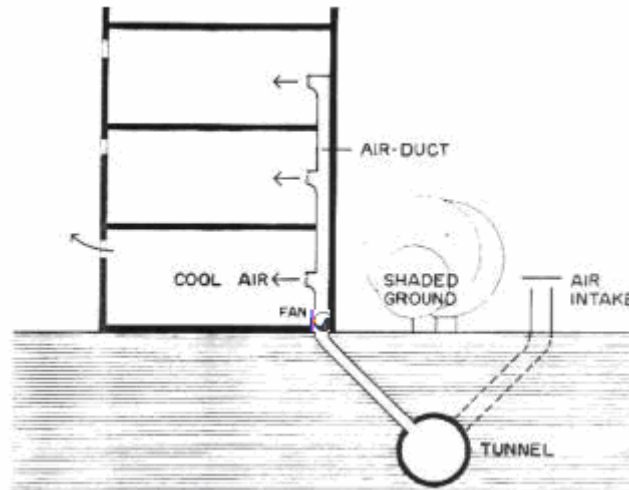

MIXED MODE VENTILATION

Some buildings may not be suitable for pure natural ventilation due to their depth or other constraints, but may make use of mixed mode with mechanical ventilation to supplement the natural ventilation. The main benefit of some augmentation by mechanical systems is that there is less unpredictability with indoor environment conditions, though it will result in greater energy use.

"Mechanical" or "forced" ventilation use fans or blowers to provide ventilation and air movement in the absence of breezes. Mechanical ventilation systems provide closer control of the area than natural ventilation systems and are less susceptible to sudden changes in ambient weather conditions. It is predictable in its operation and the airflows are controlled. The fans can be arranged in extract only, supply only and supply and extract modes.

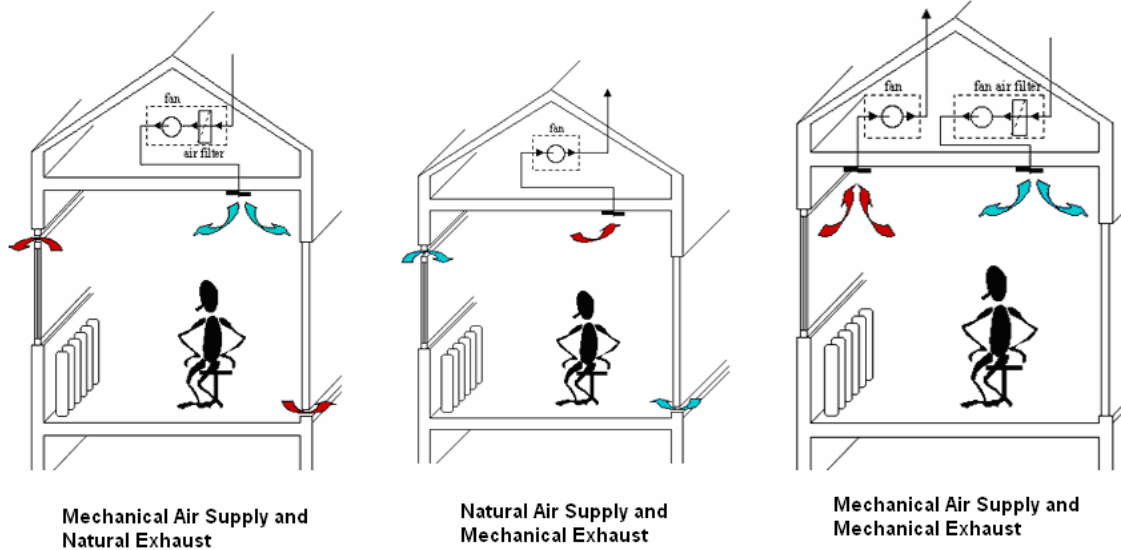

Mechanical Air Supply with Natural Air Exhaust

Here the air supply is controlled mechanically and the air exhaust takes place on a natural way by ventilation openings, windows or shafts. The arrangement shall result in positive pressurization of building with ventilator controls adjusting the air supply. An air filter can be used to ensure clean incoming air.

Natural air supply with mechanical air exhaust

This is a popular form of ventilation in residential buildings and offices. The mechanical air exhaust system creates negative pressure in the building, making sure the air is sucked in naturally through the inlet openings.

Mechanical Supply and Exhaust

In this system, the supply air and the exhaust air are transported mechanically. This arrangement offers many advantages over other form of mechanical ventilation:

- Good control of pressurization of building. Supplying more air than exhaust will result in positive pressurization of the building.
- Good control of the ventilation capacity; no dependence of the outdoor weather conditions and despite possible noisy environment
- The possibility of extracting heat from the exhaust air and use it to preheat the fresh air supply (heat recovery)
- The possibility of preheating and pre-cooling of the air supply

- The possibility of humidify and dehumidify of the air supply
- The possibility of cleaning the air by an air filter or supplying the air from a relative clean site of the building

For proper functioning of the system the building has to be sufficiently airtight.

Summary

Applications

Natural ventilation can be an appropriate choice when compared to air conditioning in the temperate climate, because the nights are cool and this can be used to pre-cool the building. Natural ventilation is ineffective in hot and humid climates where temperature swings between day and night are small. In these climates, attic ventilation can help to reduce your use of air conditioning.

If ventilation is to be used, as a rule of thumb:

- Maximize air velocities in the occupied zones for bodily cooling in hot and humid climates;
- maximize airflow throughout the building for structural cooling, particularly at night when the temperature is low for hot and arid climates;

In general, natural ventilation is:

Most suited to:

- Buildings with a narrow plan or atria with floor plate width of 15m or less
- Shallow buildings: maximum depth should not exceed 5 x floor-to-ceiling height
- Sites with minimal external air and noise pollution (though still possible if they are present)
- Open plan layouts
- Buildings with low internal gains especially in hot weather
- Buildings with low levels of external atmospheric pollution and external noise
- Buildings in temperate climate.

Not suited to:

- Buildings with a deep floor plan
- Buildings that require precise temperature and humidity control
- Buildings with individual offices or small spaces
- Buildings with continual heat loads above 35–40 W/m²
- Locations with poor air quality
- Buildings in hot and humid climates.

Benefits

- Energy costs that are 40% lower than air-conditioned equivalents
- Increased fresh air supply to a space may result in higher thermal comfort levels and increased productivity.
- Capital costs savings in the region of 10 – 15%
- More lettable area
- Natural ventilation systems may have an increased flexibility for spatial layout changes.

Drawbacks

- Natural ventilation imposes restrictions on the layout and orientation of the building in that all the ventilated spaces must be within a certain distance from an external wall.
- Increased noise pollution (from outside), odor and pollen levels (due to lack of filtration) may be concern owing to large openings.
- Screens may be required to keep out birds and insects reducing ventilation potential.
- Security issues over opening windows.
- There is a possibility in certain climates that the temperature of the slab when cooled could cause condensation.

Typical cost indicators

- Capital – Low
- Energy – Low
- Maintenance – Low

SECTION # 2

EVAPORATIVE COOLING

Evaporative cooling is a method of converting hot air into a cool breeze using the process of evaporating water. When water evaporates it absorbs a large amount of heat from its surroundings (about 1000 BTU per pound of water evaporated). The energy that is added to water to change it to a vapor comes from the environment, thus leaving the environment cooler.

Evaporative coolers utilize the natural process of water evaporation along with an air-moving system to create effective cooling. Fresh outside air is pulled through wetted filters that cool the air through water evaporation. A blower wheel then circulates the cool air throughout a room, home, or business.

This section provides an introduction to the process of evaporative cooling.

Basic Principles of Evaporative Cooling

The most familiar example of evaporative cooling is the cooling effect due to perspiration on the human skin. In hot and arid climates body temperature is partially controlled by the rapid evaporation of perspiration from the surface of the skin. In hot and humid climates, the cooling effect is less because the high moisture content of the surrounding air. Thus the rate of evaporative cooling is the function of the humidity of air.

The measurement of the amount of water vapor present in the air is called the air's humidity. There are two ways of measuring the humidity of the air: (1) absolute humidity and (2) relative humidity. Absolute humidity is the measurement of the actual quantity of water (measured in grams) in a given volume of air (measured in cubic meters or liters).

Relative humidity, the more common measurement, is the measurement of the water vapor in the air as a percentage of the maximum quantity of water vapor that the air would be capable of holding at a specific temperature. Air that is fully saturated—that is, contains as much water vapor as possible—has a relative humidity of 100 percent, while air that has only half as much water vapor as it possibly could hold at a specific temperature has a relative humidity of 50 percent.

The relative humidity varies with the temperature. As the air cools (i.e., loses energy), its ability to hold water vapor decreases, which results in an increase in the relative humidity. This is because the ability of the air to hold water vapor has been reduced by

the drop in temperature, but the absolute humidity (the actual amount of water vapor in the air) has remained unchanged. If the air temperature continues to fall the relative humidity will approach 100 percent, or complete saturation. The point at which the air is fully saturated is referred to as the dew point. At temperatures lower than the dew point, water vapor condenses out of the air onto cooler surfaces.

Performance of Evaporative Cooling Systems

Understanding evaporative cooling performance requires understanding of psychrometrics chart, which describes the thermodynamic properties of moist air.

The x-axis of the psychrometric chart represents the temperature of the humid air, also called the *dry bulb temperature* and on the y-axis; the absolute humidity also called the *humidity ratio* is depicted.

The curved lines on the psychrometric chart are the relative humidity lines. The 0% relative humidity line coincides with the dry-bulb-temperature and the saturation line on the psychrometric chart represents the 100% relative humidity, which is also the dewpoint temperature of the air.

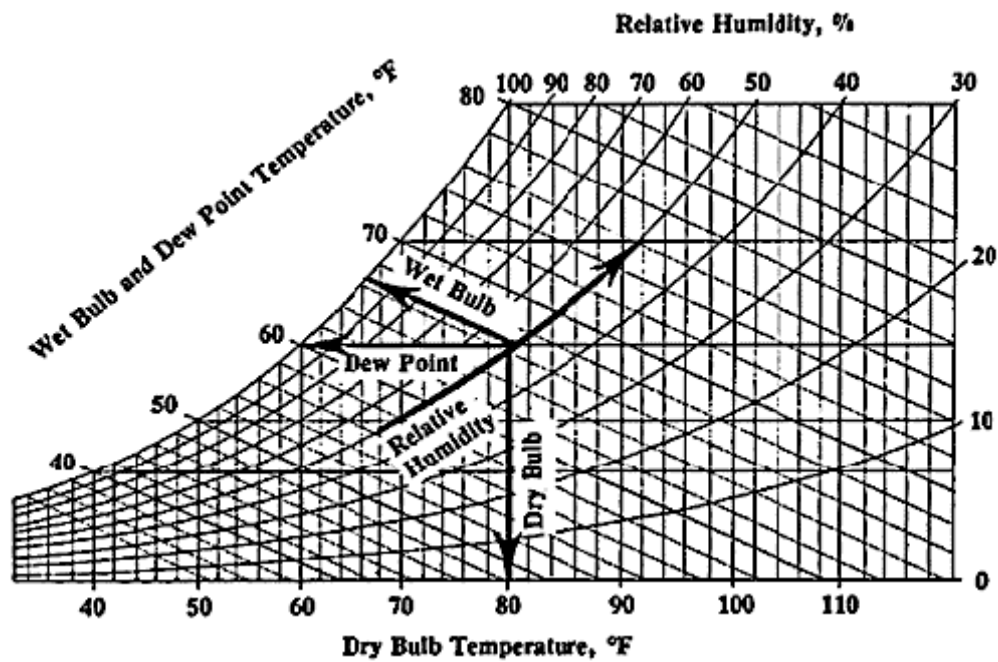

Psychrometric chart

The dew point temperature of air at less than 100% relative humidity will always be lower than the dry bulb temperature and in this way therefore the saturation of air with water vapour lowers the dry bulb temperature by means of the process known as adiabatic cooling. Some rough examples clarify this relationship:

- At 26, 7 °C (80°F) and 50% relative humidity, air may be cooled to nearly 19.4 °C (67 °F).
- At 32 °C (90°F) and 15% relative humidity, air may be cooled to nearly 16 °C (60 °F).
- At 32 °C (90 °F) and 50% relative humidity, air may be cooled to about 24 °C (75 °F).
- At 40 °C (105 °F) and 15% relative humidity, air may be cooled to nearly 21 °C (70 °F).

Maximum Cooling Potential

The extent to which evaporation can lower the temperature of a container or the air depends upon the difference between the wet and dry-bulb temperatures. Theoretically, it is possible to bring about a change in temperature equal to the difference in these two temperatures. For example, if the dry- and wet-bulb temperature were 35°C and 15°C respectively, the maximum drop in temperature due to evaporative cooling would theoretically be 20°C. In reality, though, depending on the environmental conditions, and the method of evaporative cooling used, it should be possible to achieve between 50 and 80 percent of the theoretical maximum drop in temperature. In the example given above, this would have resulted in a temperature reduction of between 10 and 16°C.

DESIGN APPROACHES

There are two general methods of evaporative cooling: direct and indirect.

Direct Evaporative Cooling:

Direct evaporative cooling involves the movement of air past a water spray (air washer/ water spraying chamber) or other wetted medium (evaporative pads, rigid media or

evaporating wheel). The air in process gets cooled due to evaporation of water and is allowed to move directly to where it is needed.

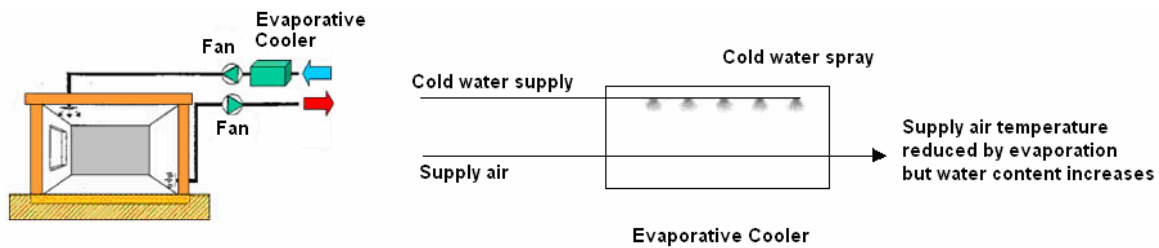

Direct evaporative cooling is represented on the psychrometric chart by a displacement along a constant wet-bulb temperature line AB:

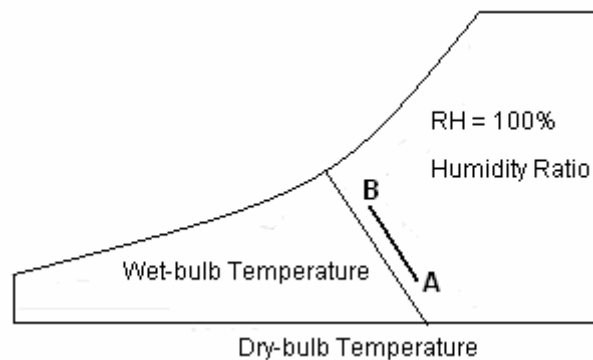

Psychrometric chart of Direct Evaporative Cooling

In process, the dry-bulb temperature of air is reduced, both relative humidity and absolute humidity is increases while the wet-bulb temperature and the enthalpy are not changed.

Since the cooled and humid air is directed into the building, the indoor air is generally not re-circulated through the evaporative cooler. Therefore, a very high rate of air flow is necessary, about 15 to 30 air changes per hour.

Indirect Evaporative Cooling:

The high level of humidity that is produced by direct evaporative cooling may be undesirable for some applications. Indirect evaporative cooling systems attempt to solve this problem with the help of a secondary heat exchanger. The cooled air leaving the direct evaporative cooler is made to exchange heat with the outside supply air in the

secondary heat exchanger. In process, the supply air temperature decreases but its water content remains constant.

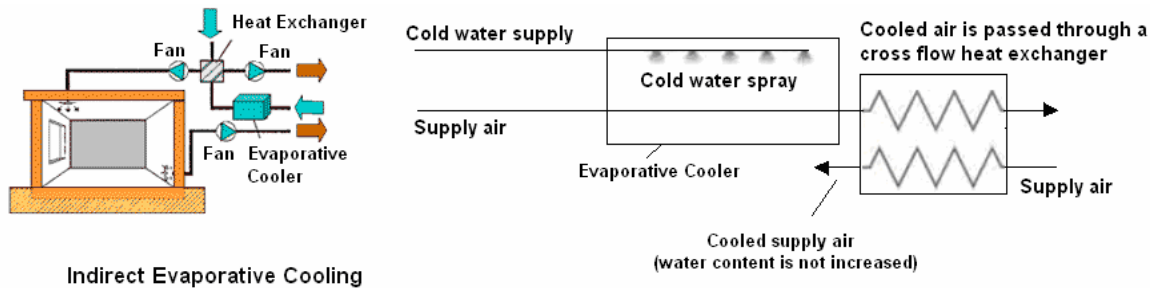

Indirect Evaporative Cooling

Since the humidity content of the cooled air does not rise, indirect evaporation cooling is represented on the psychrometric chart by a displacement along a constant humidity ratio-line CD (as cooling at any other cool surface).

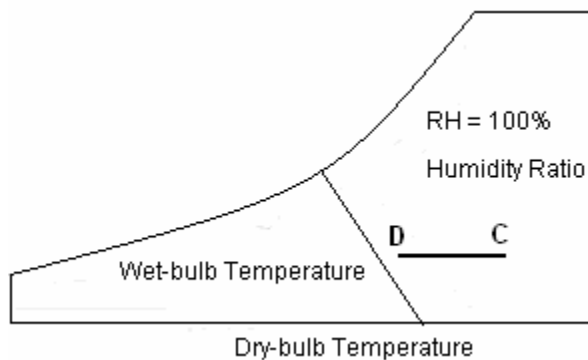

Psychrometric chart of Indirect Evaporative Cooling

Indirect evaporative cooling reduces both the dry-bulb and the wet-bulb temperature of the primary air while the humidity ratio i.e. the water content of the cooled inlet air remains unchanged (unlike in the direct evaporative cooling which adds humidity to the airstream). It must be noted that, since the air temperature drops, its relative humidity will still increase. The cooling process is represented by the line C to D.

Combined direct/indirect evaporating cooling process

The two-stage evaporative cooler combines an indirect cooler in the first stage and a direct cooler in the second stage. The psychrometric chart below shows the principle function of this system: Air to be cooled, initially at point A, is sensibly cooled by an indirect evaporative process until it reaches point B. Since the water content of the air

has not changed, line AB is parallel to the dry-bulb temperature axis. Then the air enters the second stage, where it becomes cooled down by a direct evaporative process to point C. Since this is a constant wet-bulb temperature process, line BC is parallel to the wet-bulb temperature lines.

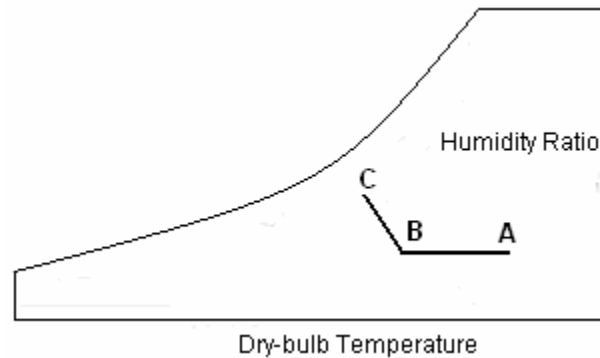

Psychrometric chart of a two-stage evaporative cooling process

Line AB represents the indirect cooling in the first stage, whereas line BC represents the direct cooling in the second stage. Two stage indirect/direct evaporative cooling results in reducing both the dry bulb and wet bulb temperatures

Performance of Direct and Indirect Evaporative Cooling

When a pound of water evaporates, almost 1000 Btu's of cooling is associated with the process. If warm dry air is blown across a medium thoroughly wetted with water, the air is cooled and its humidity is raised. If the process were 100% efficient, the temperature drop of the air would be the difference between dry bulb and wet bulb temperatures. In practical systems suitable for commercial, industrial, and agricultural use, efficiencies of 80-85% are routinely achieved. The performance of direct and indirect evaporation cooling systems can be assessed on the saturation efficiency (SE), defined as:

$$SE = \frac{T_{db,in} - T_{db,out}}{T_{db,in} - T_{wb,in}}$$

Where

- $T_{db, in}$ and $T_{db, out}$ the dry-bulb temperatures of the air at the inlet and outlet of the system as well as $T_{wb, in}$ as the wet-bulb temperature of air at the inlet of the system.

Generally the saturation efficiency of direct evaporative cooling ranges between 60-90%. Typical saturation efficiency values for indirect evaporative cooling systems are in the range of 60-80%.

FACTORS AFFECTING EVAPORATION

There are four major factors that affect the rate of evaporation.

Factor 1: Relative Humidity

When the relative humidity is low, the air is capable of taking on additional moisture, and if other conditions are also met, the rate of evaporation will be higher. On the other hand, when the relative humidity is high, the rate at which water evaporates will be low, and therefore less cooling will occur. Under such conditions, evaporative cooling can be effective if a desiccant (e.g., silica gel) is used to remove moisture from the air before it is cooled.

Factor 2: Air Temperatures

Air with a relatively high temperature stimulates the evaporation rate and is also capable of holding a relatively great quantity of water vapor. With lower air temperatures, less water vapor can be held, and less evaporation and cooling will take place. Locations with high temperatures will thus have higher rates of evaporation, and more cooling will occur.

Factor 3: Air Movement

Air movement influences the rate of evaporation. As water evaporates from a surface it tends to raise the humidity of the air that is closest to the water's surface. If this humid air remains in place, the rate of evaporation will start to slow down as humidity rises. On the other hand, if the humid air near the water's surface is constantly being moved away and replaced with drier air, the rate of evaporation will increase.

Factor 4: Surface Area

The area of the evaporating surface is another important factor that affects the rate of evaporation. The greater the surface area from which water can evaporate the greater will be the rate of evaporation. A simple example will demonstrate the importance of surface area to evaporation; consider the following two situations. (1) one liter of water placed in a narrow glass container with only about 16 cm² of surface area exposed to the air; and (2) another liter of water poured into a large shallow pan with about 180 cm² of surface exposed to the air. If both are left under the same environmental conditions, the large pan of water would dry up much sooner because of the large surface area.

Even though each of these factors has its own separate and significant effect on the rate of evaporation, when combined, their impact is much greater. For example, the first two factors can be discussed together in terms of wet and dry-bulb temperatures. Under conditions where the difference between the wet and dry-bulb temperatures is great, the rate of evaporation will also be great.

PASSIVE EVAPORATION COOLING METHODS/ALTERNATIVES

We have all experienced the result of evaporative cooling. Sitting under a tree on a hot afternoon is much cooler than sitting in the shade of a building. As water from the tree's leaves evaporates, the air surrounding the tree is gently cooled. The indoor spaces can be cooled by many other passive evaporation techniques such as:

Vegetation:

Several studies and observations concerning the role of vegetation report from an average temperature reduction of about 2-3°C.

On a sunny summer day, a normal deciduous tree can evaporate up to 1460 kg of water – the corresponding cooling effect is around 870 MJ or 240 kWh (the heat transferred by evapo-transpiration is close to 2320 kJ per kg evaporated water). Similarly, the cooling potential of one acre of grassland is about 50 GJ (~13,8MWh) on a sunny day – this potential cools the ground surface temperature about 6-8°C below the average surface temperature of bare soil. Fountains, sprays, pools and ponds are particularly effective passive cooling techniques.

Wet fiber pads:

Place wetted pads made of fibers, on the windows facing strong winds. Strong dry winds favor evaporation and humidification of the incoming air. As a drawback, such pads block the view through these windows.

Roof sprinkling:

In many buildings particularly with flat roofs; a main part of the external heat gains comes from the roof. Roof sprinkling is based on evaporation of a water mist layer created by misting spray heads on roof of the building; when the water evaporates, it absorbs large amounts of heat.

Roof ponds:

Roof pond systems are much simpler than roof sprinkling. Water ponds are constructed over flat-roofs. In order to avoid excessive water heating during the day, the water surface must be shaded. The evaporating water cools the building by conduction across the roof. Both indoor air and radiant temperatures decrease without rising indoor humidity. Since it requires the conduction through the roof, this technology should only be applied on not insulated roofs. In order to prevent high heat losses in wintertime, roof ponds are only recommended for hot climates without cold winters.

Ponds beneath the building:

Another variant of this physical method is to place ponds on the ground next to buildings, with a much larger depth of water. In this case it is possible to maintain the water temperature near or even below the average diurnal wet bulb temperature by fine spraying of the water over the insulation during the nights. The so produced cold can be used e.g. by tubes installed in the pond where warmer air of the building circulates during the day – the pond acts as a heat sink for the building.

Moving water films:

The moving water film is based on the flow of a water film on the roof surface. The increase in the relative velocity between the air and the water surface enhances the evaporation process. The effect of moving water films can also be transferred as a *direct* cooling technique by the application of water falls inside the building. In this case water flows on a wall – the drawback is that it will increase of the indoor humidity.

Volume cooling technologies:

Volume cooling techniques base on the use of a tower with water falling down, evaporating from wet pads, or being sprayed, inside. If supply air for a building is directed through this tower, it will be cooled down by evaporation. The towers work as a reverse chimney. The incoming air on the top of the tower is cooled by evaporation and since it becomes heavier, it falls to the bottom of the tower and will be directed into the building. In order to save water, the part of the water that does not evaporate can be recirculated.

Summarizing

Evaporative cooling can be employed in a strategy for cooling in predominantly hot and dry climates. Evaporative cooling can be used where:

1. Temperatures are high;
2. Humidity is low;
3. Water can be spared for this use; and
4. Air movement is available (from wind or electric fans).

Application

Principally evaporative cooling is only efficient when the relative humidity is low.

Application of Direct Evaporative Cooling Systems

Direct evaporative cooling system in general is of low capital and operational cost– their disadvantage is that humidity control is required and they cannot perform in locations with a high wet-bulb temperature. On the other hand, applied in locations with where the increase of relative humidity does not create significant problems, evaporative cooling can significantly lower energy consumption.

Direct evaporative cooling system depends on wet bulb depression – main climatic criterion for the applicability. This technology is advisable only if the Wet Bulb Temperature (WBT) in summer during daytime is at least 4K below the comfort limit (26-

30°C) in well insulated buildings (so WBT ~ 22°C) – and at least 6K in poorly insulated buildings (so WBT~ 20°C)

Application of Indirect evaporative cooling systems

This technology can only be applied in climates with high relative humidity content or when there is no relevant humidity production in the building.

Indirect evaporative coolers can operate only if the indoor wet-bulb temperature is lower than the outdoor dry-bulb temperature. In practice the indoor wet-bulb temperature should be lower than 21°C. The threshold value for the use of this system is that the wet-bulb temperature should be lower than 24°C. A humidity control is not required, since they do not release any water vapor in the inlet air

Both direct and indirect evaporative cooling systems can be designed as stand alone systems or as backup systems in conventional air-conditioning-systems. Depending on the climate, evaporative cooling can also be used to boost night-time cooling by further reducing the air temperature.

Benefits of Evaporative Cooling

- Lower energy consumption and lower CO₂ emission
- Low capital and maintenance costs.
- Indoor air quality may be improved due to higher outside air.

Drawbacks

- Not suitable for applications where tight temperature and/or humidity control is critical. Direct evaporative cooling causes rise of humidity ratio in the incoming air, raising the relative humidity of the indoor space. This works only with sufficiently ventilated spaces. Note however that indirect evaporative cooling systems do not create problems related to an increased humidity level.
- The use of a relative large quantity of high quality water limits the application of direct evaporative cooling in desert and arid regions, exactly where climatic conditions were preferable for these solutions.

- An evaporative system needs 3-4 times the air exchange rate of conventional air conditioning systems for similar cooling capacity; this means more space for the large air ducts and potential noise from the system.
- Possibility of legionella infection and hygiene requires regular maintenance.

Typical cost indicators

- Capital – Low
- Energy – Low
- Maintenance – Low

Favorable factors

- Low humidity
- Dry regions

Energy performance

Direct evaporative cooler:

- Typical electric fan power 250 W per 3600 m³/h
- Electricity consumption for the pump ~60-100 W
- Consumption of water: ~1,3 l / 0,277 kWh cooling load

Economic figures

Investment costs are a bit higher than those of standard (vapor compression) air conditioning systems: A direct evaporative cooler costs about one third (1/3), a two-stage evaporative cooler about two thirds (2/3) more than comparable mechanical cooling equipment.

SECTION # 3

DESICCANTS

Two primary objectives of active air-conditioning systems are to lower the temperature of an air stream (sensible cooling) and to reduce the humidity of an air stream (latent cooling). There are three basic methods to remove moisture from air.

1. One method is to cool the air to the dew point temperature. The dew point temperature is the temperature at which moisture will condense out of the air onto any nearby surface. Conventional mechanical HVAC systems remove moisture by cooling the supply air below the dew-point temperature. This kind of dehumidification usually requires coolant temperatures of about 6 - 12 °C, making it energy intensive operation.
2. A second method is to increase the total pressure, which causes condensation. Since the ambient pressure in HVAC applications is constant, this method does not apply to conventional refrigeration equipment.
3. A third method is to use a desiccant material. Desiccant materials have a low vapor pressure at their surface, which help attracting moisture from the air because the pressure exerted by the water in the air is higher. The pressure gradient causes water molecules to move from the air to the surface of the desiccant at a reduced vapor pressure, resulting in dehumidification of the air. Note that desiccant materials do not cool the air to condense its moisture, but rather shifts the latent cooling load to a sensible cooling load.

Desiccants can be either solids or liquids. Their surface vapor pressure is a function of their temperature and moisture content. They are further classified as two types; 1) Adsorbent desiccant and 2) Absorbent desiccant. Adsorbent desiccants collect moisture like a sponge and are usually solid materials. Water is collected on the surface and in the crevices of the material. Absorbent desiccants undergo a chemical or physical change as they collect moisture and are usually liquids or solids that change phase to liquids as they absorb moisture.

Desiccant Cooling Equipment

The most common desiccant cooling system is a combination of rotary air-to-air heat exchanger (desiccant wheel) with inner surfaces covered with a solid desiccant, e.g., silica gel, a regeneration heater (solar, gas-fired, electrical or water-heated) for removing

adsorbed water from the desiccant and evaporative cooling system. Components needed to build a solid desiccant cooling system are:

1. Desiccant rotor
2. Heating coil
3. Energy recovery system
4. Two evaporative humidifiers

These components are installed into any traditional air handling unit in a certain relation to each other. By controlling the components in sequences the system can provide cooling of supply air in summer operation.

Concept Description

Refer figure below to understand the process in steps:

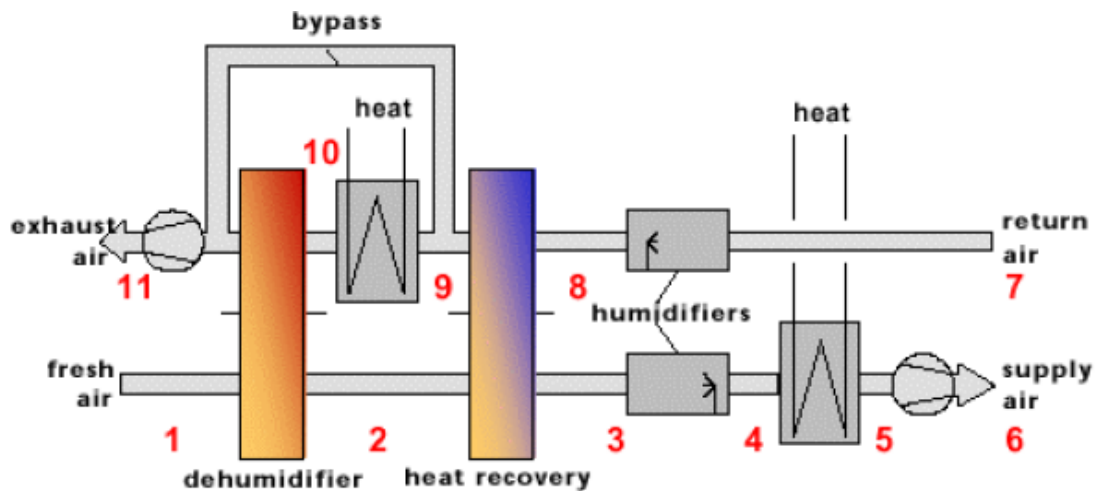

Node 1 to 2:

The desiccant cooling process begins when the air (1) is dehumidified by a rotating desiccant wheel. During dehumidification, the dry bulb temperature of the air rises because the removal of moisture results in a release of heat. The desiccant vapor pressure approaches that of the surrounding air and is no longer capable of acquiring moisture. The desiccant is then regenerated in the process of desorption by removing it from the moist air stream and heating it.

Node 2 to 3:

The dry-bulb temperature is then reduced by a heat recovery system without altering moisture content

Node 3 to 4:

An evaporative humidifier increases the moisture content of the air in proportion to reduction in dry bulb temperature (state condition 4).

Node 4 to 5:

The coil on the supply stream is in operation only for heating conditions. Not applicable for cooling conditions.

Node 5 to 6:

The fan delivers air to the space. In process the supply air temperature is increased a little owing to fan heat.

Node 6 to 7:

Air is supplied to the space at condition 6 and is returned back at thermal condition 7 for heat recovery.

Node 7 to 8:

Return air is generally passed through another evaporative humidifier where the return air temperature is reduced and moisture content increased close to saturation (8). This guarantees the maximum potential for indirect cooling of the supply air stream through the heat exchanger for heat recovery.

Node 8 to 9:

This colder air is transferred via the sensible heat recovery wheel from (8) to (9), subsequently leads to an increase in the temperature of the air, which is the use as regeneration air.

Node 9 to 10:

This return air is subsequently reheated in the coil until it reaches state (10).

Node 10 to 11:

The temperature of the latter is elevated to a level sufficient to reactivate the desiccants in the desiccant wheel (10 to 11).

The use of heat for the regeneration process is the highest energy requirement of the system. The elevated temperature of the return air duct removes moisture from the desiccants and the wheel will then absorb moisture again. Typical desiccant reactivation temperatures required in the return air duct are 70-80°C and air will be exhausted from the system at typically 40-50°C. A proportion of return air may bypass the heater and desiccant wheel in order to minimise energy consumption.

Liquid Desiccants

The desiccant system described previously uses solid desiccants i.e. silica gel or lithium chloride; liquid desiccant systems use a liquid spray of desiccant solution such as lithium bromide. The development of liquid desiccant systems compared to solid desiccant systems is still in its infancy although it is claimed that liquid desiccant systems have the potential advantage of better efficiency as dehumidification and heat transfer take place simultaneously rather than sequentially.

Desiccant System Rated Capacity

A common source of confusion with desiccant systems is the rating of capacity and the measurement of efficiency because drying of air does not necessarily involve cooling. The desiccant cycle is driven by thermal energy.

The efficiency of the cycle improves for desiccant materials that have a high moisture capacity and low mass. The ideal desiccant dehumidification system is characterized by an infinite surface area for moisture collection and an infinitely small mass. These characteristics result from the fact that the required heating and cooling energy is directly proportional to the mass of the desiccant and the mass of the mechanism that presents the desiccant material to the air stream.

System capacity can be rated in terms of water removal rate (lb/hr), airflow capacity (cfm), or cooling capacity (tons). However, the moisture removal rate varies depending on input and output conditions. There are currently no industry-accepted standard methods of calculating COP for desiccant dehumidification systems (American Gas Cooling Center 1994). Sources of variance in quoted values of COP include the heat sources used for regeneration, the source of regeneration air, and method of cooling the

dehumidified air. Manufacturer quotes of COP should be carefully examined to determine how COP is defined (American Gas Cooling Center 1994). A better method of comparing alternative systems to desiccant refrigeration is to calculate an equivalent cooling load for the desiccant system that achieves the desired level of humidity. This equivalent load can then be used to compare desiccant systems to alternative refrigeration systems.

U.S Code Acceptance

The Air-Conditioning and Refrigeration Institute (ARI) has published a new standard, ARI Standard 940-98 "Desiccant Dehumidification Components," that applies to thermally regenerated desiccant components.

Summarizing.....

Applications

Desiccant dehumidification is particularly attractive in applications where building exhaust air is readily available for an energy-recovery ventilator (ERV, or "passive" desiccant system) or where a source of waste heat from other building operations is available to regenerate the desiccant system.

Types of Desiccant Materials

Types of materials used as a basis for desiccant systems include the following materials:

- Silica Gel
- Lithium Chloride (Liquid or Dry)
- Lithium Bromide
- Activated Alumina
- Titanium Silicate

Commercially available desiccant systems are based on five configurations or technologies.

- Liquid Spray Towers
- Solid Packed Tower
- Rotating Horizontal Bed

- Multiple Vertical Bed
- Rotating Desiccant Wheel

Benefits/Costs

- Desiccant dehumidification systems are growing in popularity because of their ability to remove moisture from outdoor ventilation air while allowing conventional air conditioning systems to deal primarily with control temperature. Desiccant cooling systems decrease cooling energy needs and increase comfort. Mechanical ventilation improves indoor air quality and desiccant cooling helps further improve air quality by lowering humidity and removing potential pollutants.
- Desiccant cooling is a potentially environmentally friendly technology for cooling buildings particularly if solar energy is used for the reactivation process. Taking advantage of a continuous and regenerative process makes it possible to control the indoor air humidity without using chlorofluorocarbons [(CFCs) a refrigerant linked to ozone depletion], HCFC or HFC refrigerants which are harmful to the ozone layer.
- The materials used for desiccant cooling are neither hazardous to the environment nor toxic to people.
- The electric power demand of such a system drops remarkably when compared with a conventional HVAC system utilizing compressor-driven cooling.

Limitations

- The first costs of a desiccant cooling system might be as high as for a conventional HVAC system with compression chiller and cooling tower.
- Many of the features that make desiccant units appear attractive are actually not applicable in many situations. For example, desiccant units themselves are free of chlorofluorocarbons (CFCs). However, if sensible cooling is required, it will be necessary to use some type of additional refrigeration system that may contain CFCs. The claim that desiccant systems will result in downsizing existing chillers is also not true in many situations for which a moderate degree (greater than 36 grains/lb) of dehumidification is required. Desiccant systems in these applications may require a larger power input than equivalent vapor-compression systems.

- Desiccant systems do not necessarily have lower annual maintenance costs. Desiccant systems have many more components, such as additional fans, ducts, and a boiler, all of which must be maintained. Solid desiccants will also decay with use and will eventually require replacement.
- Some solid desiccant material will inevitably be lost in the air stream and swept away. Additional filtration of air will be needed.

SECTION # 4

ABSORPTION CHILLERS

The absorption cycle is a process by which refrigeration effect is produced through the use of two fluids and some quantity of heat input, rather than electrical input as in the more familiar vapor compression cycle. Both vapor compression and absorption refrigeration cycles accomplish the removal of heat through the evaporation of a refrigerant at a low pressure and the rejection of heat through the condensation of the refrigerant at a higher pressure. The method of creating the pressure difference and circulating the refrigerant is the primary difference between the two cycles. The vapor compression cycle employs a mechanical compressor to create the pressure differences necessary to circulate the refrigerant. In the absorption system, a secondary fluid or absorbent is used to circulate the refrigerant. Because the temperature requirements for the cycle fall into the low-to-moderate temperature range, and there is significant potential for electrical energy savings, absorption would seem to be a good prospect for geothermal application.

Absorption chillers are either lithium bromide-water (LiBr-H₂O) or ammonia-water equipment. The LiBr-H₂O system uses lithium bromide as the absorber and water as the refrigerant. The ammonia-water system uses water as the absorber and ammonia as the refrigerant.

Figure below shows a schematic of a single-effect LiBr-H₂O absorption chiller. The process occurs in two vessels or shells. The upper shell contains the generator and condenser; the lower shell, the absorber and evaporator.

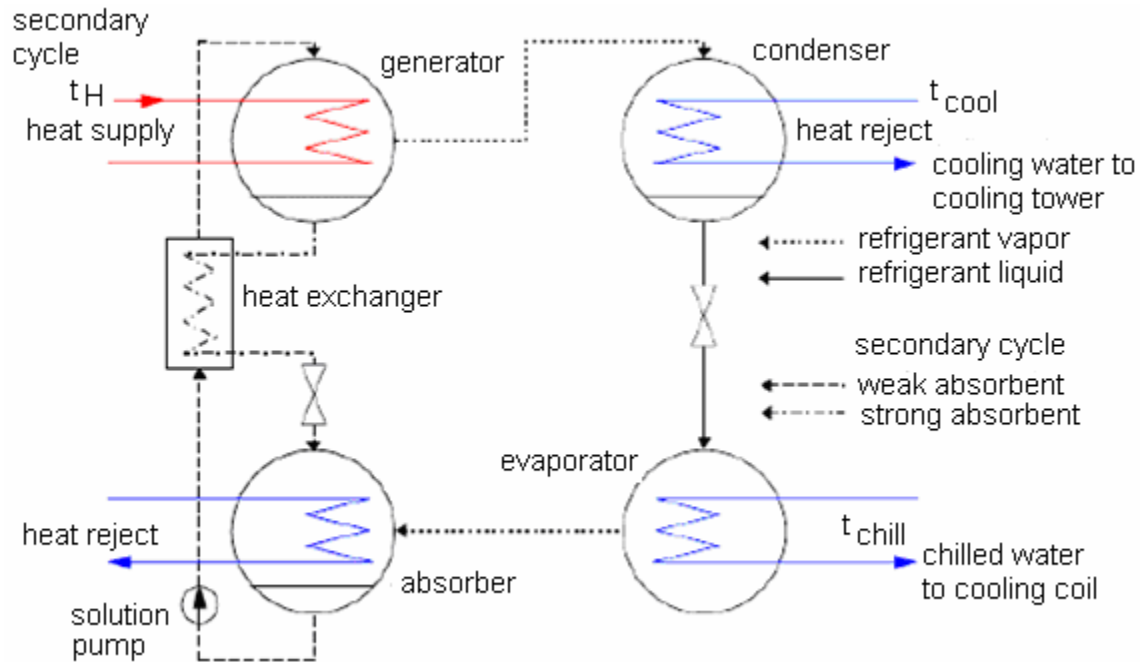

LiBr-H₂O absorption process

The evaporator, which is under a partial vacuum, allows the refrigerant (water) to evaporate and to be absorbed by the absorbent, a process that extracts heat from the building. The combined fluids then go to the generator, which is heated by the gas or steam, driving the refrigerant back out of the absorbent. The refrigerant then goes to the condenser to be cooled back down to a liquid, while the absorbent is pumped back to the absorber (via heat exchanger). The cooled refrigerant is released through an expansion valve into the evaporator, and the cycle repeats.

Absorption chillers are generally classified as direct- or indirect-fired, and as single, double - or triple-effect. In direct-fired units, the heat source can be gas or some other fuel that is burned in the unit. Indirect-fired units use steam or some other transfer fluid that brings in heat from a separate source, such as a boiler or heat recovered from an industrial process. Hybrid systems, which are relatively common with absorption chillers, combine gas systems and electric systems for load optimization and flexibility.

Single Effect

Single-effect LiBr/H₂O absorption chillers use low pressure steam or hot water as the heat source. As shown in Figure, there are three fluid circuits that have external connections: a) generator heat input, b) cooling water, and c) chilled water. Associated

with each of these circuits is a specific temperature at which the machines are rated. For single-stage units, these temperatures are: 12 psi steam (or equivalent hot water) entering the generator, 85°F cooling water, and 44°F leaving chilled water. Under these conditions, a coefficient of performance (COP) of approximately 0.65 to 0.70 could be expected. The COP can be thought of as a sort of index of the efficiency of the machine and is calculated by dividing the cooling output by the required heat input. For example, a 500-ton absorption chiller operating at a COP of 0.70 would require: $(500 \times 12,000 \text{ Btu/h})$ divided by 0.70 = 8,571,429 Btu/h heat input. This heat input suggests a flow of 9,022 lbs/h of 12 psi steam, or 1,008 gpm of 240°F water with a 17°F ΔT .

The thermal efficiency of single-effect absorption systems is low. Most new single-effect machines are installed in applications where waste heat is readily available. Single-effect chillers can be used to produce chilled water for air conditioning and for cooling process water, and are available in capacities from 7.5 to 1,500 tons.

Double Effect

The desire for higher efficiencies in absorption chillers led to the development of double-effect LiBr/H₂O systems. The double-effect chiller differs from the single-effect in that there are two condensers and two generators to allow for more refrigerant boil-off from the absorbent solution. The higher temperature generator uses the externally supplied steam to boil the refrigerant from the weak absorbent. The refrigerant vapor from the high temperature generator is condensed and the heat produced is used to provide heat to the low temperature generator.

These systems use gas-fired combustors or high pressure steam as the heat source. Double-effect absorption chillers are used for air-conditioning and process cooling in regions where the cost of electricity is high relative to natural gas. Double-effect absorption chillers are also used in applications where high pressure steam, such as district heating, is readily available. Although the double-effect machines are more efficient than single-effect machines, they have a higher initial manufacturing cost. There are special materials considerations, because of increased corrosion rates (higher operating temperatures than single-effect machines), larger heat exchanger surface areas, and more complicated control systems.

Summarizing.....

Application

There is no simplifying rule of thumb to help determine when absorption chillers should be used; a life-cycle cost analysis should be performed on a case-by-case basis to determine whether this is an appropriate technology. The primary variable that drives the economics of absorption cooling is the electric demand charge. Ideal candidates for absorption applications are those where the peak demand charge is high. Since cooling is generally the primary cause of sharp spikes in a building's electric load profile, it is advantageous to investigate alternatives that can reduce this peak. Absorption cooling minimizes or flattens the electric peaks in a building's electric load.

Generally, absorption chillers may make sense in the following situations:

- Electric demand charges are high
- Electricity use rates are high
- Summertime natural gas prices are favorable
- Utility and manufacturer rebates exist
- Where waste heat can be utilized
- Locations with electric load limitations

Benefits/Costs

Absorption machines allow waste stream to be utilized more efficiently and in the proper application can result in substantial energy savings.

Using an absorption chiller instead of a compression chiller reduces the electrical power demand significantly, resulting in more favorable electricity rates. With absorption chiller operation, the peak power demand is determined by the power demand of the lighting and the equipment rather than by the cooling demand.

A clear advantage over the compression cooling process is offered by the refrigerants used in the absorption cooling process which are less harmful to the environment than CFCs, HCFCs or HFCs.

Limitations

- Vapor absorption systems operate in near vacuum. Every effort must be made to keep the system air-tight, as even very small leaks can cause problems and are difficult to detect. Air entering the machine causes:
 - The lithium bromide solution to become highly corrosive to metals;
 - The lithium bromide solution to crystallize;
 - The chilled water temperature to increase;
 - Refrigeration capacity to decrease.
- Absorption refrigeration machines are generally more difficult to operate and require more maintenance than reciprocating and centrifugal machines. One problem associated with these machines is “Crystallization”, which occurs when the lithium bromide solution does not go through the normal dilution cycle. When this happens, the solution becomes so concentrated that it crystallizes and plugs the solution lines. The unit must then be shut down and decrystallized. Crystallization can be caused by a power failure, controller malfunction, extreme variations in the condenser water temperature, or operator error in inadvertently allowing air to enter the machine. It is indicated by a rise in the outlet chilled-water temperature, a loss of solution pump (or a noisy solution pump), a loss of solution level in the absorber, and generator flooding.
- The absorption process reject higher amount of heat that requires a bigger fan or even a bigger cooling tower and consumes more water.
- Absorption chillers are usually more expensive than compression chillers and needs bigger space.

SECTION # 5

RADIANT & RADIATIVE COOLING

Radiant systems have been used for cooling by circulating a chilled fluid through capillary tubes embedded behind drywall/plaster or metal ceiling. The cold capillary mats above drywall/plaster ceiling then absorbs the thermal energy radiating from people and their surroundings (sensible load), lowering the mean radiant temperature of the room. Water is distributed through capillary tubes approximately 1/16 inch in diameter and spaced at about 1/8 inch apart.

The major difference between cooled ceilings and air conditioning is the heat transport mechanism. Air conditioning uses convection only using air distribution through ductwork, but radiant cooling uses a combination of radiation and convection. The amount of radiant heat transfer can be as high as fifty five percent, while convection accounts for the remainder.

There are four main types of radiant cooling system designs:

1. The panel system, built from aluminum panels with metal tubes, connected to the side of the panel facing away from the conditioned space;
2. Cooling grids, made of small plastic tubes placed close to each other can be embedded in plaster or gypsum board. Cooling grids can also be mounted on ceiling panels such as acoustic ceiling elements. Because the plastic tubes are flexible the cooling grid system may be the best choice for retrofit applications;
3. Concrete core cooling system consists on embedded plastic tubes in the core of the concrete ceiling: the thermal storage capacity of the ceiling allows for peak load shifting but limits the ability to control the concrete core system. Relatively high surface temperatures are therefore required for the ceiling, to avoid the uncomfortable conditions that would occur in the case of a sudden drop in loads. This high temperature requirement limits the cooling power of the system. The system is particularly suited for coupling with alternative cooling sources, especially the heat exchange with cold night air;
4. Cooling by a raised floor: in this system the ventilation supply plenum is located under the floor. Air is supplied below the windows, reducing the radiative effect of cold window surfaces in winter and hot window surfaces in summer.

Applications

Most radiant cooling applications are based on aluminum panels suspended from the ceiling, through which cool water at 15°C or more is circulated. To be effective, the panels must be maintained at a temperature very near the dew point temperature. The space humidity must be kept low otherwise condensation will occur at surfaces. To avoid condensation at the cold surfaces, dew-point sensors can be installed to either switch off the chilled water supply or increase the water temperature when the dew-point temperature of the room air approaches the temperature of the water supply.

Key Benefits

Radiation provides most of the cooling, using water as the transport medium. The radiant cooling systems can remove a given amount of thermal energy using less than 5% of the fan energy that would otherwise be necessary.

- Thermal energy storage in the panel structure, exposed walls and partitions reduces peak loads for greater energy efficiency;
- No drafts or temperature swings for the ultimate in comfort;
- Eliminates the need for individual air conditioning units, especially where window-mount units are more prevalent;
- Eliminates the need for mechanical equipment within the conditioned room, increasing square-footage space (especially valuable in hospital patient rooms and other applications where space is at a premium);
- Noisy fans and blowers dispersing dust and other allergens are eliminated, increasing indoor air quality (particularly valuable where maximum cleanliness is essential or where dictated by legal requirements);
- The duct work is needed only to convey fresh air which is only about 20% of the space requirements of conventional HVAC systems. This reduces the cost for ductwork, insulation as well provide higher ceilings.
- Centrally located mechanical equipment offers simplified maintenance and operation.

Drawbacks

The panels cover most of the ceiling, leading to high capital expense for the systems.

Radiant systems are essentially air-and-water systems that separate the task of ventilation and thermal space conditioning by using a separate dedicated primary air distribution to fulfill the ventilation requirements. This adds to the capital costs.

In all but the most arid locations, an auxiliary air-conditioning system may be required to keep the space humidity low, adding further to the capital cost.

NATURAL RADIATIVE COOLING FOR BUILDINGS

Radiative cooling is the process by which a body loses heat by radiation. In the case of the buildings it refers to the process by which the building envelope radiates towards the sky and gets cooler, thus enhancing the heat transfer out of the interior of the building.

Concept Description

Radiative cooling is based on the physical principle of equilibrium; i.e. if two bodies of different temperatures are facing one another without any medium between them, a net radiant heat flux from the hotter body will occur. If the cooler element is kept at a fixed temperature, the other element will cool down to reach equilibrium. In the context of radiative cooling, the building envelope represents the body with the higher temperature; the sky is the body with lower temperature. The sky temperature is often much lower than ambient air temperature at ground level, particularly in clear and dry conditions. The sky emits longwave* infrared radiation downwards whereas a building emits longwave infrared radiation upwards: if the latter outweighs the former, net radiative cooling occurs.

* Longwave radiation refers to infrared (thermal) radiation between 5 and 100 microns in wavelength, which is the bandwidth at which the earth rejects heat into space via the atmosphere. Shortwave radiation refers to radiation below 5 microns in wavelength, that is, the incoming solar radiation.

Technical Description

All objects emit energy by electromagnetic radiation. This radiation is due to the molecular and atomic agitation associated with the internal energy of the material, which in the equilibrium state is proportional to the absolute temperature of the material (measured in K). This radiation is called thermal radiation. The major part of it emitted within a narrow band of the electromagnetic spectrum, between 0.1 and 100 μm . For theoretical reasons, the so-called black body was defined. This is an “ideal body” that adsorbs all the incident radiation impinging on it, for all wavelengths and all angles of incidence of radiation, and then emits radiation at one defined wavelength, which depends on its temperature. The emission from real bodies is evaluated relative to the emission of the black body under the same conditions, using a coefficient called emissivity.

The total hemispherical emissive power of a black body is calculated with the Stefan-Boltzmann law:

$$M = \sigma \cdot T^4 \quad [\text{w}/\text{m}^2]$$

Where

- M - the total radiated power per unit surface area of a black body in unit time (W/m^2)
- T - temperature of the body
- σ - Stefan-Boltzmann-constant ($5,67 \cdot 10^{-8} \text{ Wm}^{-2}\text{K}^{-4}$)

The total hemispherical power of a real body is characterized by its emissivity ϵ . The total emissive power of a real body is thus:

$$M = \epsilon \cdot \sigma \cdot T^4$$

The radiative heat exchange flux between two bodies with their specific emissivity is calculated by the equation:

$$M = \sigma \cdot (\epsilon_1 \cdot T_1^4 - \epsilon_2 \cdot T_2^4)$$

Where in the special case of radiative cooling:

- ϵ_1 : emissivity of the radiating roof
- T_1 : temperature of the radiating roof
- ϵ_2 : sky-emissivity
- T_2 : sky-temperature

Without the atmosphere, the sky would be close to an ideal black body, adsorbing all thermal radiation from the Earth. Due to its specific composition, the atmosphere itself emits thermal radiation at all wavelengths except in the spectral region of 8-13 μm – the so called “sky or atmospheric window”. This region is very close to the emitted wavelength of a black body at a temperature equal to the dry-bulb temperature of the air close to the ground.

What influences radiative cooling process?

Several physical and ambient conditions influence or limit the radiative cooling process:

Cloudiness:

The clouds in atmosphere influences the emissivity– a cloudy sky has about 45% of the sky radiation potential of a clear sky.

Humidity / Moist atmospheric conditions:

The water vapor in atmosphere influences the emissivity – humid locations see a higher effective sky emissivity and thus less radiative cooling potential. Often cloudiness and moist atmospheric conditions go together. Ozone and aerosols affect atmospheric thermal radiation, too, but it has shown that their effect is less important than that of water.

Convection / Wind:

Night cooling can be strongly affected by winds. As building surfaces fall below the ambient air temperature, they begin to gain heat by air convection. Still air and windless conditions around the radiating surfaces will increase nocturnal radiation. Blowing winds

with air temperatures higher than the radiator can decrease the cooling power by up to 50%.

View factor:

The extent by what a roof sees the sky for radiative heat exchange depends on the relative angle of the emitter (roof) and the absorber (night sky). Generally, horizontal surfaces will have the greatest exposure to the sky for the purpose of radiation, while those vertically inclined will not. The factor describing this is the view-factor, which is related to the geometry of a body relative to the sky. A simple rule of thumb is that a horizontal roof has a view factor equal to one, while a vertical wall with an unobstructed view will have a view factor of one third.

Available Radiative Cooling Methods

White roof:

White roofs are the traditional and technically easiest way for radiation cooling. The advantage of light colors or white is that the sun is reflected during daytime. Because of the high long-wave emissivity of white painted surfaces, it efficiently exchanges heat with sky during night and its temperature remains lower during the day.

Certain off-the-shelf white paints have been shown to keep roof surface temperatures near ambient temperature during day and up to 6 °C below at night. Coatings and tiles such as SiO, MgO and LiF have been tested with results suggesting the possibility of net radiative cooling day and night.

Movable canvas cover:

If external shading devices are used on the building surface, they should not interfere with night time cooling. This is particularly important for roof surfaces which are exposed to the cool night sky. A solid cover of concrete or galvanized iron sheets will shade the roof from solar radiation but it will not permit radiation to the night sky. An alternative method is to provide a cover of deciduous plants or creepers. Because of evaporation from the leaf surfaces the temperature of such a cover will be lower than the day time air temperature and at night it may even be lower than the sky temperature. This will result in a very cool roof surface even if the day time shading is not 100%.

An inexpensive and effective roof shading device is a removable canvas cover. This can be mounted close to the roof in the day time and at night it can be rolled up to permit radiative cooling. The upper surface of the canvas should be painted white to reduce transmission of radiation through the material and to make it more durable. Surface temperatures can be controlled by evaporation of water also.

Another shading device used in some traditional buildings is the covering of the entire roof surface with small closely packed inverted earthen pots. In addition to shading, such an arrangement provides increased surface area for radiation emission and insulation cover of still air over the roof which impedes heat flow into the building while still permitting upward heat flow at night. Although it is thermally efficient, this method suffers from practical difficulties as the roof is rendered unusable and is difficult to maintain.

Movable Insulation Systems:

Movable or flexible insulation systems are applied on the roofs of buildings. During the day the mass is covered by an insulating layer to minimize heat storage due to solar radiation. During night the insulation layer is opened to allow the exposure of the thermal mass to the roof. The advantage of such a system is that it can be inverted during winter, i.e. during daytime the mass is exposed to the sun and insulated during night in order to reduce heat losses.

Movable Thermal Mass (water based):

This system is a variant of the flexible insulation described above. Here, beneath the flexible insulation a water reservoir (pond) is fixed on the roof. By day it is covered by an insulation layer and during night it cools down because of radiation. The water circulates in the embedded tubes in building mass, or alternatively through radiant panels; taking the heat from the space

The disadvantage of this system is additional costs for a reinforced buildings structure. Attention must be paid to the impermeability of the roof and pumps are needed to circulate the water. Several variations of this system are possible –some combinations of evaporative cooling and radiative cooling concept.

Combination with Evaporative Cooling

A newer, more innovative use of evaporative cooling is night-sky radiant cooling. This approach works in climates with large diurnal temperature swings and generally clear nights (such as in the Southwest). Water is sprayed onto a low-slope roof surface at night, and the water is cooled through a combination of evaporation and radiation. This process typically cools the water to 5-10°F (2.7-5.5°C) below the night air temperature.

The water drains to a tank or circulates through tubing embedded in a concrete floor slab. Daytime cooling is accomplished either by circulating cooled water from the tank or through passive means from the concrete slab.

Summarizing.....

Applications

For new buildings construction requirements (roof, slab cooling, static, space for cool or rain water storage) must be considered, as well as the planning of necessary technical equipment. In the case of retrofit buildings the application of this technology is only suited during a basic renovation cycle, which touches the roof as well as the technical equipment of a building.

Note: For a radiative cooling system, the specific cooling load depends on the available roof surface (typical values for daily cooling capacities are 50 – 200 Wh/m² of roof surface). The cooling capacity is only linked to the roof surface. In a multi-storey office building the cooling capacity is further reduced according to the presence of storey's (e.g. in a 4 storey office building this leads to a cooling capacity of ~12.5 - 50 Wh/m²).

Benefits

- Lower cooling energy costs
- Synergies and cost reduction with other applications possible for example rainwater collection + Cooling
- Systems with water storage can improve building's fire protection

Typical cost indicators (relative to a conventional HVAC system)

- Operating costs – low

- Operating maintenance costs – low
- Investment costs - higher

Performance

Specific cooling energy yields of ~ 200 Wh/m²d (roof surface) are possible. Typical cooling load reduction is less than 150 Wh/m²d (office surface). Reduction of peak loads by less than 10 W/m² (office surface).

Check criteria

Favorable Factors:

- Operation in climates with dry cooling seasons
- Combination with thermal mass activation favorable

Un-favorable Factors:

Less adapted in moist and windy climates

Design requirements:

- Appropriate roof construction (static, emissivity, water spraying, roof slope, etc.)
- Appropriate building design (thermal mass activation or combination with building air handling units etc.)
- Integral planning necessary
- Free view to the night sky (view factor) – probably not appropriate in high-density urban areas

SECTION # 6

GROUND COOLING

Ground cooling system involves the concept of routing air through underground metal or plastic tubes or chambers. The idea is that as the air travels through the pipes, it gives up some of its heat to the surrounding soil, and thus entering the space as cooler air. They use the earth's near constant subterranean temperature to cool the air.

A cooling tube system uses either an open- or closed-loop configuration. In an open-loop system, outdoor air is drawn into the tubes and delivered directly to the inside of the building. This system provides ventilation while cooling the building's interior. In a closed-loop system interior air circulates through the earth cooling tubes. A closed loop does not exchange air with the outside; instead the system recirculates the indoor air through the earth cooling tubes. This makes the closed loop system more efficient than an open loop design, since it does not require as high a degree of dehumidification as an open loop system.

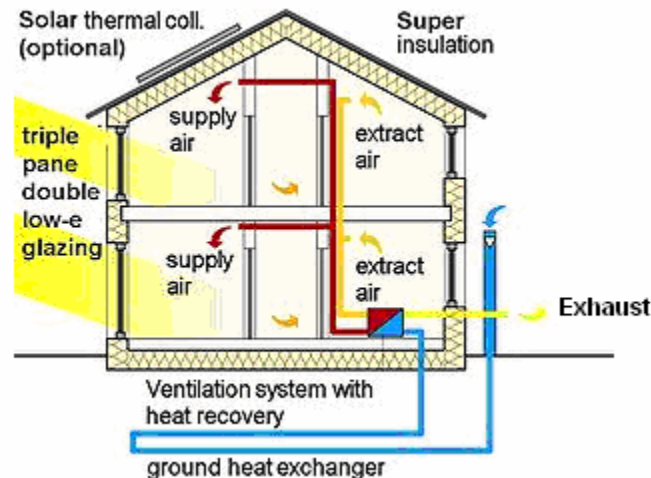

Design Considerations for Earth Cooling Systems

Tube Material:

The main considerations in selecting tube material are cost, strength, corrosion resistance, and durability. Tubes made of aluminum, plastic, and other materials have been used. The choice of material has little influence on thermal performance. PVC or polypropylene tubes perform almost as well as metal tubes; they are easier to install, and are more corrosion resistant.

Tube Diameter:

Optimum tube diameter varies widely with tube length, tube costs, flow velocity, and flow volumes. The various installations use tubes anywhere from 4 to 18 inches.

For residential applications, somewhere in the 4 to 12 inch category is probably sensible. Obviously, multiple 4 inch pipes would need to be used to get the same cooling as one 12 inch pipe.

Tube Location:

Earth temperatures and, consequently, cooling tube performance vary significantly from sunny to shady locations. Where possible, the inlets in open loop systems and the cooling tubes themselves should be placed in shady areas.

Tube Depth:

As a general rule, the ground temperature at 20 ft down does not vary over the year, and that it is equal to the average yearly air temperature at that location. This probably varies with the soil type, moisture content, and ground cover, but may be generally helpful ground rule.

Tubes should be buried at least 6 ft below grade. Only rarely is burying them more than 12 ft is justifiable. When digging trenches at these depths, cave-ins are an extreme hazard, and appropriate precautions should be taken.

Tube Length:

There is no simple formula for determining the proper tube length in relation to the amount of cooling desired. Local soil conditions, soil moisture, tube depth, and other site-specific factors should be considered to determine the proper length. In general:

- The longer you make the earth tube, the closer the air flowing through the tube will get to the earth temperature.
- But, there is a diminishing returns effect as the tube gets longer and longer.
- Somewhere around 75 to 100 ft might be pretty close to the sweet spot.
- The temperature change in the tube air after 150 ft appears to be small.
- As the tubes get longer, the cost to install them goes up, and the fan energy to drive air through them also goes up.

Soil Properties:

The amount of heat conducted and how widely it is diffused varies from one soil type to another. The moisture content of the soil is a major influence on conductivity and diffusivity, and accounts for large variations on how heat moves through the earth.

Rules on Laying:

- Pipes must be laid at a depth of at least 6 ft;
- For best possible heat transfer, pipe should be laid in solid ground (not laid in sand). Make sure the ground is well compressed around the pipes;
- The pipes are to be laid at least 3 ft from the building and from each other;
- The fall of the pipes is to be approx 2 %;
- The pipes should be cut using a fine toothed saw or pipe cutter. Pipes are to be cut square and the ends are to be de-burred and slightly chamfered;
- Seals are to be cleaned and checked for damage before being inserted. The chamfered pipe end is to be coated with lubricant and the pushfit socket is then inserted.

Potential Problems:

Earth cooling tubes are likely to perform poorly in hot, humid areas, because the ground does not remain sufficiently cool at a reasonable depth during the summer months. Mechanical dehumidifiers will most likely be necessary since moisture control, another important aspect of thermal comfort is difficult to achieve with earth cooling.

The dark and humid atmosphere of the cooling tubes may be a breeding ground for odor-producing molds and fungi.

Earth cooling tube systems can be very expensive and may not offer attractive payback considering the current electricity tariffs.

HEAT PUMPS

Another variant of earth cooling system is the cooling of air through geothermal heat pumps. A heat pump, as the name suggests, is a device that "pumps" heat from one location to another. In cooling mode, heat pumps transfer the heat in an enclosed area to the outside environment and in heating mode the process is reversed in a way that it extracts heat from the outside environment and pumps it indoors. Thus heat pumps allow indoor environments to be heated as well as cooled using the same technology.

These are broadly classified as air source and geothermal heat pumps – both used for heating and cooling applications.

Air Source Heat Pumps

The most popular heat pump is the air-source type (air-to-air), which operates in two basic modes:

- As an air-conditioner, a heat pump's indoor coil (heat exchanger) extracts heat from the interior of a structure and pumps it to the coil in the unit outside where it is discharged to the air outside (hence the term air-to-air heat pump) and
- As a heating device the heat pump's out door coil (heat exchanger) extracts heat from the air outside and pumps it indoors where it is discharged to the air inside.

Geothermal Heat Pumps

Geothermal heat pumps are similar to ordinary heat pumps, but instead of using outside ambient air for heat rejection/extraction, they rely on the relatively constant temperature of the shallow earth as a source of heat in the winter and as a repository for heat in the summer.

In winters, the fluid passing through the underground (or underwater) loops of piping is warmed by the Earth's heat. The collected heat is extracted and concentrated by the heat pump, and distributed through the building's ductwork. To cool the building in the summer, this process is reversed — the heat pump moves heat from the indoor air into the underground loops, where it is transferred to the relatively cooler ground. The heat removed from the indoor air during the summer can also be used to produce some of your hot water, or to heat swimming pools, instead of transferring it to the ground.

Geothermal heat pumps use electricity to heat and cool, just like a conventional heat pump, however, unlike the conventional heat pump, geothermal heat pumps save approximately 30 to 40% of the energy. The earth's constant temperature is what makes geothermal heat pumps one of the most efficient, comfortable, and quiet heating and cooling technologies available today. While they may be more costly to install initially than regular heat pumps, they can produce markedly lower energy bills - 30 percent to 40 percent lower, according to estimates from the U.S. Environmental Protection Agency, who now includes geothermal heat pumps in the types of products rated in the EnergyStar® program. Because they are mechanically simple and outside parts of the

system are below ground and protected from the weather, maintenance costs are often lower as well.

Basic Elements of Geothermal Heat Pumps

Geothermal Heating and Cooling Systems has three major subsystems or parts: a geothermal heat pump to move heat between the building and the fluid in the earth connection, an earth connection for transferring heat between its fluid and the earth, and a distribution subsystem for delivering heating or cooling to the building.

The geothermal loop that is buried underground is typically made of high-density polyethylene, a tough plastic that is extraordinarily durable but which allows heat to pass through efficiently. The fluid in the loop is water or an environmentally safe antifreeze solution that circulates through the pipes in a closed system. Another type of geothermal system uses a loop of copper piping placed underground. When refrigerant is pumped through the loop, heat is transferred directly through the copper to the earth.

Types of Loops

Geothermal heat pump systems are usually not do-it-yourself projects. To ensure good results, the piping should be installed by professionals who follow procedures established by the International Ground Source Heat Pump Association (IGSHPA). Designing the system also calls for professional expertise: the length of the loop depends upon a number of factors, including the type of loop configuration used; your space heating and air conditioning load; local soil conditions and landscaping; and the severity of your climate. Larger areas requiring more heating or air conditioning generally need larger loops than smaller buildings. Here are the typical loop configurations:

Open Loop Systems:

Open loop systems are commonly called "pump and dump" systems. Here the water is pumped from a well to the system and is returned to another well or discharged on the surface. Generally, two to three gallons per minute per ton of capacity are necessary for effective heat exchange. Since the temperature of ground water is nearly constant throughout the year, open loops are a popular option in areas where they are permitted. Open loops have the advantage of higher equipment performance since the source water is used only once and then discharged, but have significant environmental concerns:

- Some local ground water chemical conditions or improperly installed plumbing can pose risk of contamination to aquifers and can lead to fouling the heat pump's heat exchanger. Discharge of water may require a permit from the local pollution control agency;
- Open-loop systems that discharge warmed water may have an impact on surface-water quality, plants, fish, winter oxygen levels, and the integrity of the ice surface during winter (a safety issue).

Also the costs of pumping water through an open loop are usually somewhat higher than those associated with circulating water through a closed loop.

Closed Loop Systems:

A closed loop is one in which both ends of the loop's piping are closed. The water or other fluid is recirculated over and over and no new water/fluid is introduced to the loop. The heat is transferred thru the walls of the piping to or from the source, which could be ground, ground water, or surface water. System efficiencies are somewhat lower in closed loop operation, but the costs of pumping the water are lower as compared to open loops.

Types of Closed Loops

The closed-loop geothermal systems can be configured as horizontal, vertical or directly immersed in the bed of a body of water. The choice is determined by the heating and cooling loads of the building, the duration of occupancy, the bin weather data of the area, availability of land, and the soil and geological characteristics.

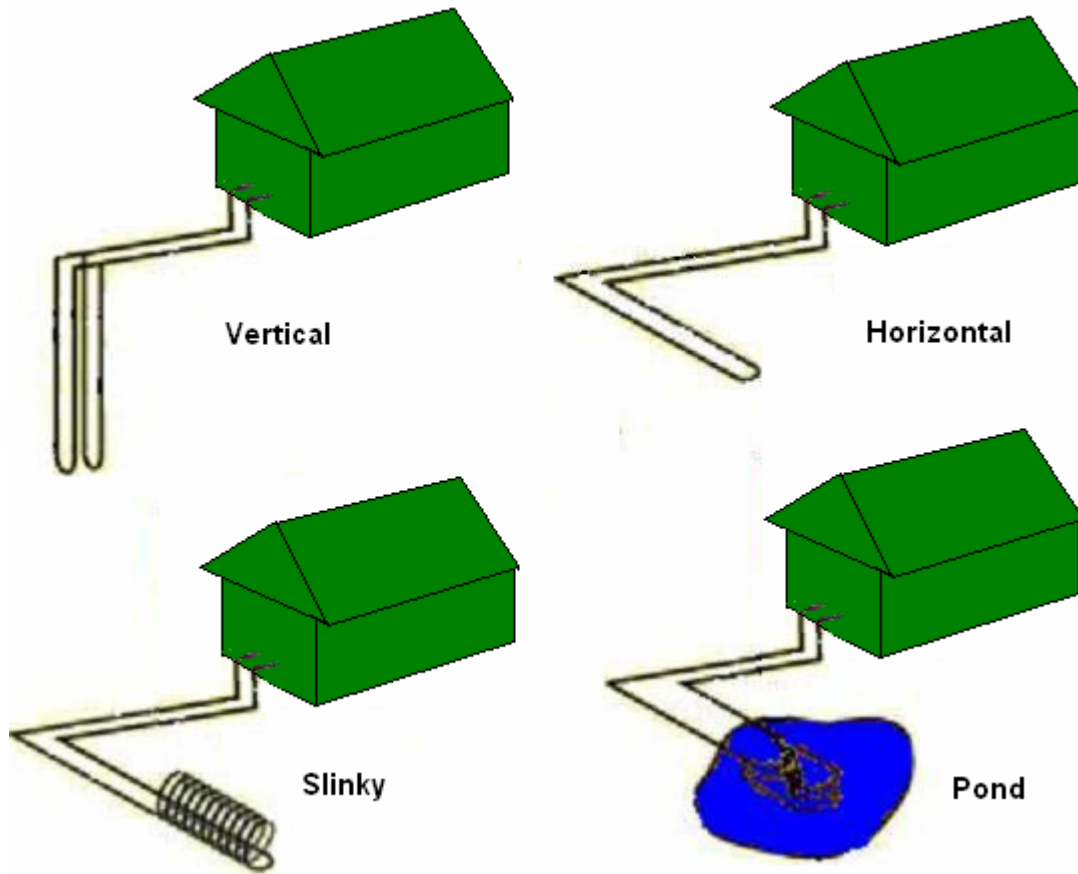

Horizontal Loops:

Horizontal Loops are often considered when adequate land space is available. The pipes are placed in trenches (approx 3 feet wide), excavated by a backhoe or chain trencher to a depth of 4-6 feet. Depending on design, 1 to 6 pipes are installed in each trench. Trench lengths range from 100-400 feet per system ton. Trenches must be spaced from 6-10 feet apart.

Multiple pipe and coiled “slinky” configurations are often used to conserve land requirements and reduce overall installed loop costs.

The overall land area required ranges from 750-1500 square feet per system ton.

Vertical Loops:

In vertical loop installation, deep holes are bored into the ground and pipes with U-bends are inserted into the holes, the holes are grouted, the piping loops are manifolded together, brought into the structure and closed. The argument for this type of ground-loop heat exchanger is that because the piping is in the deeper ground - unaffected by

surface temperatures - performance will be higher. Generally, installed costs are higher than with a horizontal loop.

Vertical Loops are the ideal choice when available land area is limited but may require numerous well holes drilled deep enough vertically for the geothermal loops. Bore hole diameter ranges from 4 to 6 inches and depth ranges from 100-200 feet per system ton. Bores must be spaced from 10-15 feet apart and properly grouted.

Potential concerns

Generally, no concerns are associated with in-ground, closed-loop systems. However, impacts of closed-loop system on lakes, rivers, or ground water could include the following:

- A submerged heat exchanger could be damaged by motorboat propellers or anchors even if it is well marked, especially during periods of low water.
- A poorly installed or maintained structure may break down, causing the heat-transfer fluid to spill into surface water or ground water.
- A line break in the lake could degrade water quality, fish, and plants. If several homeowners have loops submerged in a lake, habitat and navigation on the lake could be affected by the loops.

Pond Loops:

Pond closed loops are a special kind of closed loop system. Where there is a pond or stream that is deep enough and with enough flow, closed loop coils are anchored to the bottom in the body of water. Fluid is pumped just as for a conventional closed loop ground system where conditions are suitable and the loops use the energy stored in the body of water, rather than in the earth.

Pond (Lake) loops are very economical to install when a body of surface water is available, because excavation costs are mostly eliminated. Coils or “slinky” mats of pipe are simply placed on the bottom of the pond (lake). In most cases, 1/4 to 1/2 acre of water surface, with a minimum depth of 8-10 feet, is needed for a typical residence.

Direct Exchanger (DX) Geothermal Heat Pumps

A direct exchange (DX) geothermal heat pump system, also called "direct expansion" or "DX geo" is a geothermal heat pump system where refrigerant circulates through copper

pipes placed in the ground. The refrigerant exchanges heat directly with the soil through the walls of the copper pipes. This direct exchange, or should we say "x-change", eliminates the polyethylene water pipe and water pump to circulate water found in water-source geothermal heat pumps.

Direct Exchange Components

The copper tubing consists of a line set, a pair of manifolds (sometimes called headers), and several earth loops. The line set is the pair of main copper pipes coming from the heat pump compressor unit, usually located indoors. One line is for the liquid refrigerant, the other is for gaseous refrigerant. The line set runs through the building wall and runs underground to the location of the manifolds. Each manifold - one for gas and one for liquid - attaches the main pipe to the earth loops which exchange heat with the ground.

The refrigerant lines are connected to the compressor, which increases the pressure and temperature of the refrigerant. Heat energy released by the pressurized refrigerant may be channeled either to the building if heat is needed or to the earth if cooling is needed. The process is controlled by a thermostat and a reversing-valve.

The refrigerant line may then be run from the compressor to an air handler. The air handler is used to transfer heat from the refrigerant to the air and circulate the heated air through ductwork, or to remove it from the building in summer by exchanging it from the circulating air into the refrigerant line for transport to the earth.

Alternatively the heat can be distributed as radiant in-floor heating by running the refrigerant line from the compressor to a refrigerant-to-water heat exchanger that is used to transfer heat into a hot water circulating system to heat the building. It can also be used to heat a home's domestic water through integrated full-demand water heating, or through "desuperheating" to capture waste heat from the air conditioning cycle and move it to the water heater.

Advantages of Geothermal System

The extremely high levels of efficiency are possible because a geothermal heat pump only uses electricity to move heat, not produce it. A geothermal unit typically supplies 4 kilo watts of heat for every kilowatt of electricity used. Three of these kilowatts of heat come directly from the earth itself, and are clean, free, and renewable. Overall, geothermal technology offers the highest cooling efficiency available in the industry and

is an environmentally friendly as well as safe and healthy alternative to conventional refrigeration systems.

THERMOELECTRIC HEAT PUMPS

Thermoelectric heat pumps perform the same cooling function as refrigerant-based vapor compression. In all such units, thermal energy is extracted from a region, thereby reducing its temperature, then rejected to a "heat sink" region of higher temperature. Vapor-cycle devices have moving mechanical parts and require a working fluid, while thermoelectric elements are totally solid state miniature devices. These units are easily capable of reducing the temperature to well below freezing. It is possible to build thermoelectric systems in a space of less than 1 cubic inch. In addition to the space and weight saving advantages, thermoelectric offer the utmost in reliability due to their solid state construction.

Thermoelectric heat pumps utilize solid state modules composed of an array of n- and p-type semiconductors connected electrically in parallel and thermally in series. The semiconductors are sandwiched between metalized ceramic plates to afford optimum electrical insulation and thermal conduction with high mechanical strength in compression. The thermoelectric module absorbs heat at one end of the device and rejects heat at the opposite end when the module is connected to a DC power source. This phenomenon is known as the "Peltier effect". If the current flow is reversed, the direction of the heat flow is reversed.

Concept Description

Since thermoelectric cooling systems are most often compared to conventional systems, perhaps the best way to show the differences in the two refrigeration methods is to describe the systems themselves.

A conventional cooling system contains three fundamental parts - the evaporator, compressor and condenser. The evaporator or cold section is the part where the pressurized refrigerant is allowed to expand, boil and evaporate. During this change of state from liquid to gas, energy (heat) is absorbed. The compressor acts as the refrigerant pump and recompresses the gas to a liquid. The condenser expels the heat absorbed at the evaporator plus the heat produced during compression, into the environment or ambient.

Thermoelectric coolers are heat pumps – solid state devices without moving parts, fluids or gasses. The basic laws of thermodynamics apply to these devices just as they do to conventional heat pumps, absorption refrigerators and other devices involving the transfer of heat energy. An analogy often used to help comprehend a thermoelectric cooling system is that of a standard thermocouple used to measure temperature. Thermocouples of this type are made by connecting two wires of dissimilar metal, typically copper/constantan, in such a manner so that two junctions are formed. One junction is kept at some reference temperature, while the other is attached to the object being measured. The system is used when the circuit is opened at some point and the generated voltage is measured. Reversing this train of thought, imagine a pair of fixed junctions into which electrical energy is applied causing one junction to become cold while the other becomes hot.

A thermoelectric has analogous parts. At the cold junction, energy (heat) is absorbed by electrons as they pass from a low energy level in the p-type semiconductor element, to a higher energy level in the n-type semiconductor element. The power supply provides the energy to move the electrons through the system. At the hot junction, energy is expelled to a heat sink as electrons move from a high energy level element (n-type) to a lower energy level element (p-type). Thermoelectric cooling couples are made from two elements of semiconductor, primarily Bismuth Telluride, heavily doped to create either an excess (n-type) or deficiency (p-type) of electrons. Heat absorbed at the cold junction is pumped to the hot junction at a rate proportional to current passing through the circuit and the number of couples.

The performance of a thermoelectric cooler depends on the figure of merit of the semiconductor materials composing the p-n junctions. Typical compounds are quaternary alloy of bismuth, tellurium, selenium and antimony - doped and processed to yield oriented polycrystalline semiconductors with anisotropic thermoelectric properties. Typical n-type compounds are 75% Bismuth Telluride (Bi_2Te_3) and 25% Bismuth Selenide (Bi_2Se_3). Typical p-type compounds are 75% Selenium Telluride (Sb_2Te_3) and 25% Bismuth Telluride (Bi_2Te_3) with about 2 percent excess Te or Se.

Modules are available in a great variety of sizes, shapes, operating currents, operating voltages and ranges of heat pumping capacity. The present trend, however, is toward a larger number of couples operating at lower currents. Modules can be mounted in

parallel to increase the heat transfer effect or can be stacked in multistage cascades to achieve high differential temperatures.

Thermoelectric Selection Factors

There is usually a "need" to use thermoelectric instead of other forms of cooling. The "need" may be a special consideration of size, space, weight, reliability and environmental conditions such as operating in a vacuum. If none of these is a requirement, then other forms of cooling should be considered and, in fact, are probably desirable. Once it has been decided that thermoelectric are to be considered, the next task is to select the thermoelectric(s) that will satisfy the particular set of requirements. Three specific system parameters must be determined before device selection can begin. These are:

- TC, Cold Surface Temperature
- TH, Hot Surface Temperature
- QC, The amount of heat to be absorbed

Cold Surface of the thermoelectric (TC):

The cold surface temperature is usually the desired temperature of the object. Generally, if the object to be cooled is in direct intimate contact with the cold surface of the thermoelectric, the desired temperature of the object can be considered the temperature of the cold surface of the thermoelectric. There are situations where the object to be cooled is not in intimate contact with the cold surface of the thermoelectric, such as volume cooling where a heat exchanger is required on the cold surface of the thermoelectric. When this type of system is employed, the cold surface of the thermoelectric may need to be several degrees colder than the ultimate desired object temperature.

The Hot Surface Temperature (TH):

The hot surface temperature is defined by two major parameters:

1. The temperature of the ambient environment to which the heat is being rejected;
2. The efficiency of the heat exchanger that is between the hot surface of the thermoelectric and the ambient.

These two temperatures (TC & TH) and the difference between them (ΔT) are very important parameters and therefore must be accurately determined if the design is to operate as desired. The design of the heat sink is a critical aspect of a good thermoelectric system. The heat sink must be able to reject heat load from the system. If the heat load is not rejected from the system, the temperature of the entire system will rise and the load temperature will increase. Increasing the current to maintain a specific load temperature results in a reduced efficiency.

The amount of heat to be absorbed (QC):

The third and often most difficult parameter to accurately quantify is the amount of heat to be removed or absorbed by the cold surface of the thermoelectric. All thermal loads to the thermoelectric must be considered. These thermal loads include, but are not limited to, the active or I^2R heat load from electronic devices and conduction through any object in contact with both the cold surface and any warmer temperature (i.e. electrical leads, insulation, air or gas surrounding objects, mechanical fasteners, etc.). In some cases radiant heat effects must also be considered.

Single stage thermoelectric devices are capable of producing a "no load" temperature differential of approximately 67°C. Temperature differentials greater than 67°C can be achieved by stacking one thermoelectric on top of another. This practice is often referred to as Cascading. The design of a cascaded device is much more complex than that of a single stage device, and is beyond the scope of these notes.

Applications

Thermoelectric (Peltier) heat pumps are capable of refrigerating a solid or fluid object well below freezing. Thermoelectric coolers are suitable for applications that require mobility, such as beverage or medical coolers and are most suitable for precisely temperature controlled scientific, military and aerospace applications. Typical applications include:

Medical/Laboratory	Industrial/Commercial	Consumer	Military/Aerospace
Temperature controlled therapy pads	Dewpoint hygrometers	Picnic box coolers and heaters	Electronic equipment cooling

Medical/ Laboratory	Industrial/Commercial	Consumer	Military/Aerospace
Protein coolers	Osmometers	Air conditioned motorcycle helmets	Photo scanning equipment cooling
DNA amplifiers	Electronic enclosure coolers	Small refrigerators	Military avionics
Blood analyzers	Dehumidifiers		Infrared detectors
Constant temperature baths	CCD housing and cameras		Thermal viewers
Cold chambers	Integrated circuit coolers		Black body references
Cold-hot plates/ centrifuges	Temperature calibration systems		Space telescope cameras

Benefits

Thermoelectric refrigeration for units that generate small amounts of cooling (a fraction of a ton) has several advantages.

- It is possible to build thermoelectric systems in a space of less than 1 cubic inch. In addition to the space and weight saving advantages, thermoelectric offer the utmost in reliability due to their solid state construction.
- Thermoelectric coolers are composed of solid state semiconductors and have no moving parts. They offer the utmost reliability and noiseless operation.
- These systems are energized by a DC power input and therefore most suitable for mobile applications.
- Thermoelectric coolers are environmentally friendly because they use no CFCs or chemical refrigerants.

Limitations

Thermoelectric devices are not the solution for every cooling problem. You should consider them when your system design criteria include such factors as high reliability,

small size or capacity, low cost, low weight, intrinsic safety for hazardous electrical environments, and precise temperature control.

Attainable COP for thermoelectric cooler is lower than conventional vapor compression systems. Thermoelectric systems are also quite expensive.

Concluding.....

Appropriate resource management is a key requirement for the HVAC systems towards addressing global concerns of man's growing impact on the environment. The various passive cooling strategies discussed in this course when effectively implemented, enable energy conservation and promote sustainability. Not all the passive cooling methods will be useful in every application and set of conditions. It is important to evaluate what an ideal HVAC system would look like for your application. Although compromises sometimes have to be made, they should be made with proper knowledge of your site conditions, available technology, materials, skills and economic considerations.
